

STIGA

Reservdelskatalog Parts Catalogue

DINO 47

292470148/S16 - Season 2017

- Use GLOBAL GARDEN PRODUCT Genuine Spare Parts specified in the parts list for repair and/or replacement.
 - The contents described in the parts list may change due to improvement.
 - The drawings of the spare parts are only indicative and might not represent the part in question exactly.
 - The indications "right" - "left" - "front" - "rear" refer to the position of the operator when using the machine.
- When placing orders of parts for repair and/or replacement, make sure that the illustrated parts list is the one applying to the machine's year of manufacture, as shown on the identification plate attached to the machine.

© Copyright 2017 Global Garden Products

All rights reserved. No part of this material may be reproduced or transmitted, in any form or by any means, electronic or mechanical, including photocopying, recording or by any information storage and retrieval system, without permission in writing from GLOBAL GARDEN PRODUCTS.

www.stiga.com

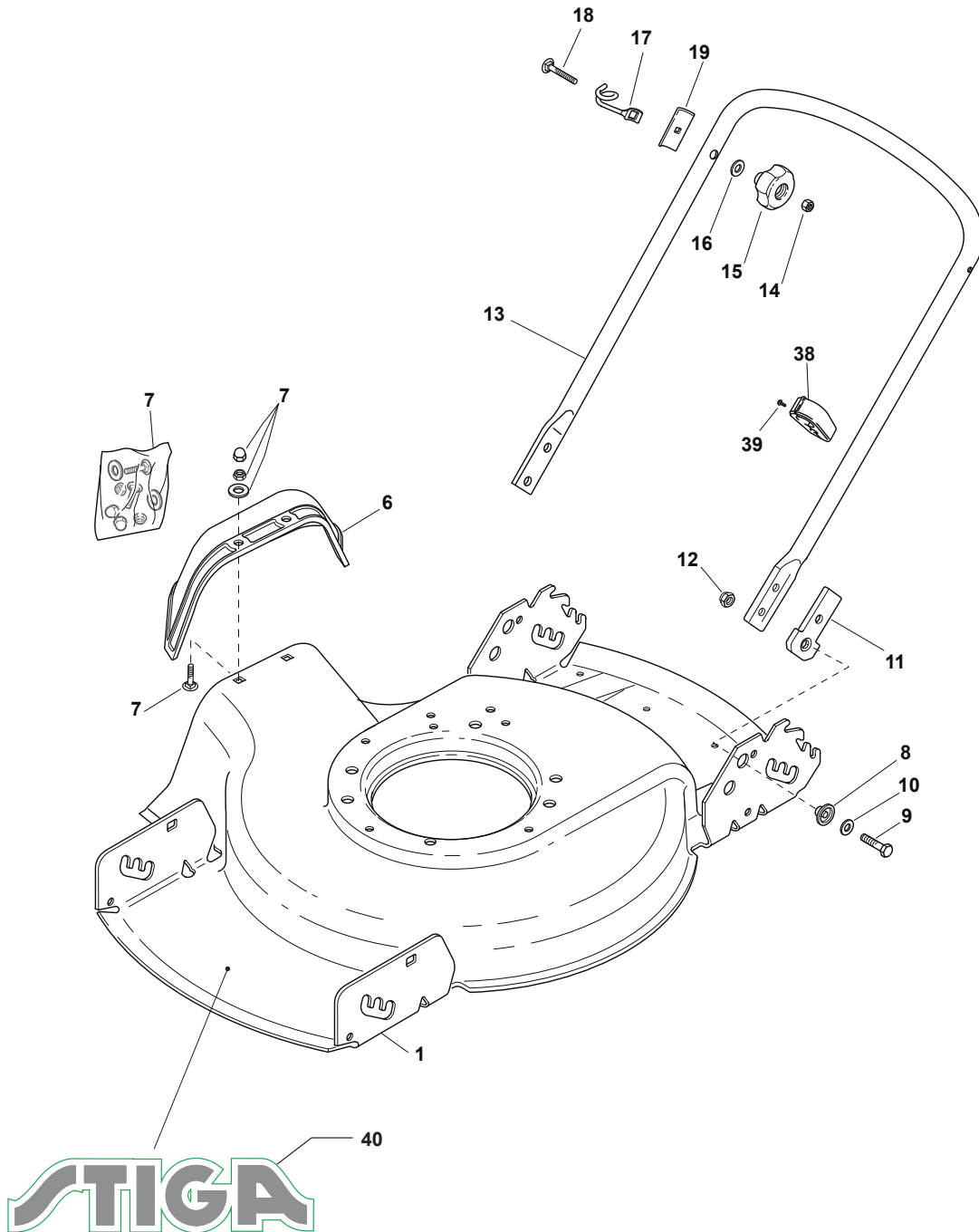

Utgåva Issue 39 - 2016		Kapa Deck			
Pos. Fig.	Antal Q.ty	Art nr Part No	Benämning	Description	Anmärkning Notes
1	1	381004733/0	Chassi gra	Grey Deck	
6	1	322600159/0	Lucka - svart	Stone Guard, Black	
7	1	381008502/0	Skruvsats	Outfit, Screws	
8	4	322041958/0	Bussning	Bushing	
9	4	112793701/0	Skruv	Screw	
10	4	122671651/0	Bricka	Washer	
11	2	322551577/0	Isoleringsplatta	Isolation Plate	
12	4	112155000/0	Mutter	Nut	
13	1	381007548/0	Reglage, nedre Gul	Handle, Lower Part Yellow	Yellow
14	2	112361005/0	Mutter	Nut	
15	2	322399810/0	Ratt	Knob	
16	2	112521350/0	Bricka	Washer	
17	1	122430311/0	Fjäder	Starting Rope Guide Spring	
18	2	112820655/0	Skruv	Screw	
19	2	322545137/0	Förstärkning Sp/O 3X30X50	Handle, Upper Part	
38	1	322192001/0	Fäste	Clamp	
39	1	112728691/0	Skruv	Screw	
40	1	114367494/2	Dekal STIGA logo	Label STIGA logo	

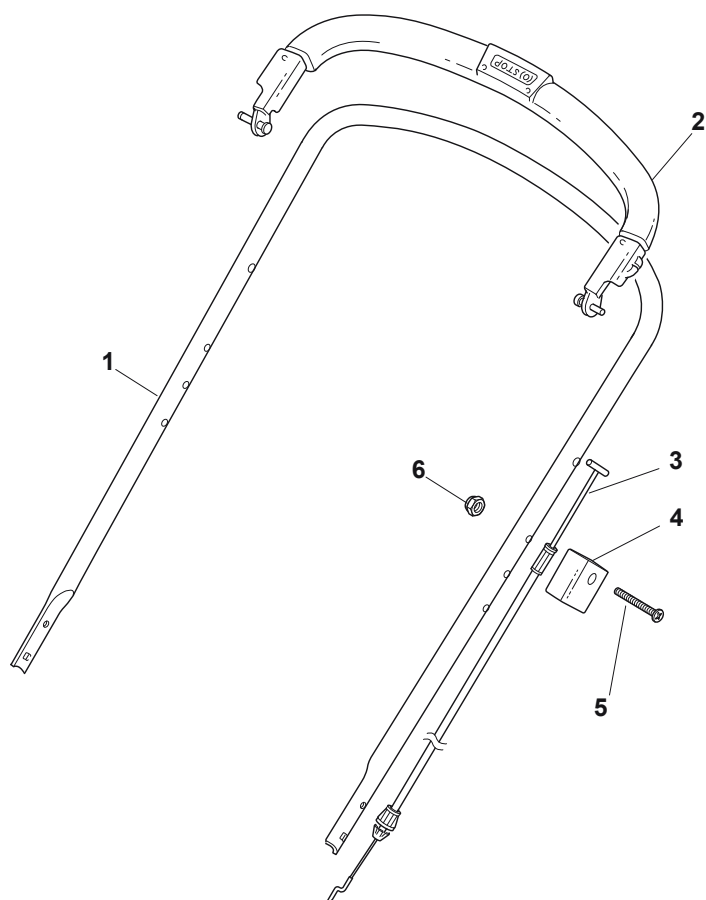

Utgåva Issue 39 - 2016		Reglage, övre Handle, Upper Part			
Pos. Fig.	Antal Q.ty	Art nr Part No	Benämning	Description	Anmärkning Notes
1	1	381006632/1	Styre-överdel	Handle, Upper Part	Yellow
2	1	381003298/1	Reglagebygel	Lever, Engine Brake	
3	1	181000685/0	Motorbromswire	Cable, Thread Engine Brake	GGP Engine
4	1	322551640/0	Plat	Plate	
5	1	112727783/0	Skruv	Screw	
6	1	112154510/0	Mutter	Nut	

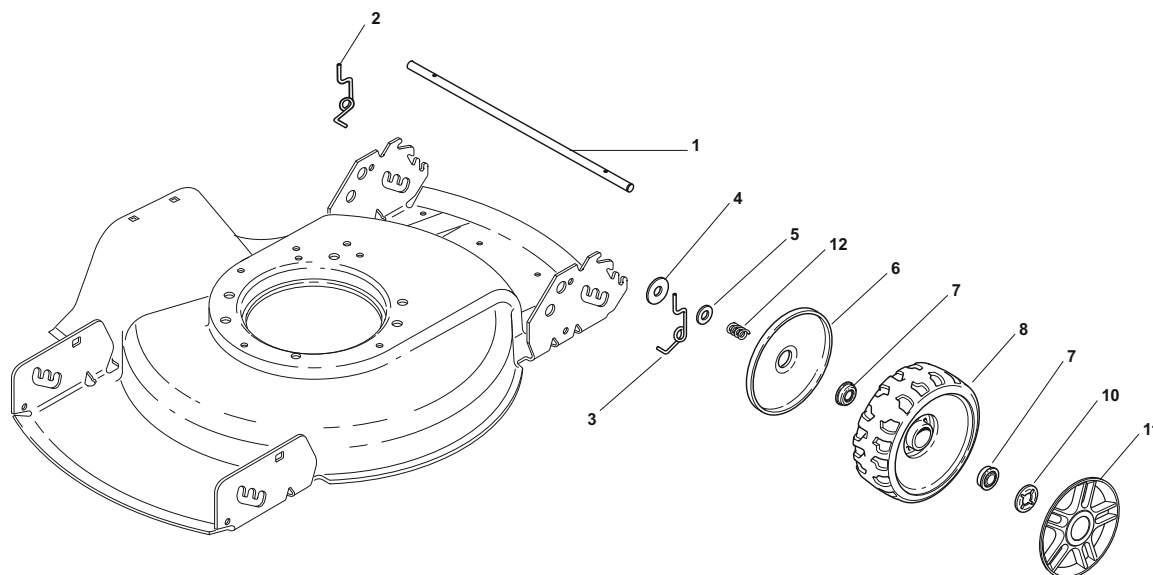

Utgåva Issue 39 - 2016		Hjul och navkapsel Wheels and Hub Caps			
Pos. Fig.	Antal Q.ty	Art nr Part No	Benämning	Description	Anmärkning Notes
1	2	322033395/0	Hjulaxel	Axle	
2	2	122450442/0	Fjäder	Spring, Right	
3	2	122450441/0	Fjäder	Left Spring	
4	4	122671654/0	Bricka	Washer	
5	4	112521370/0	Bricka	Washer	
6	4	322600095/0	Hjulskydd	Protection, Wheel	
7	8	122122200/0	Kullager	Bearing	
8	4	322686091/1	Hjul	Wheel	
10	4	122020050/0	Lasbricka	Ring	
11	4	322110491/0	Navkapsel D170 Gra	Hub Cap Grey	Grey
12	4	122430215/0	Fjäder	Spring	

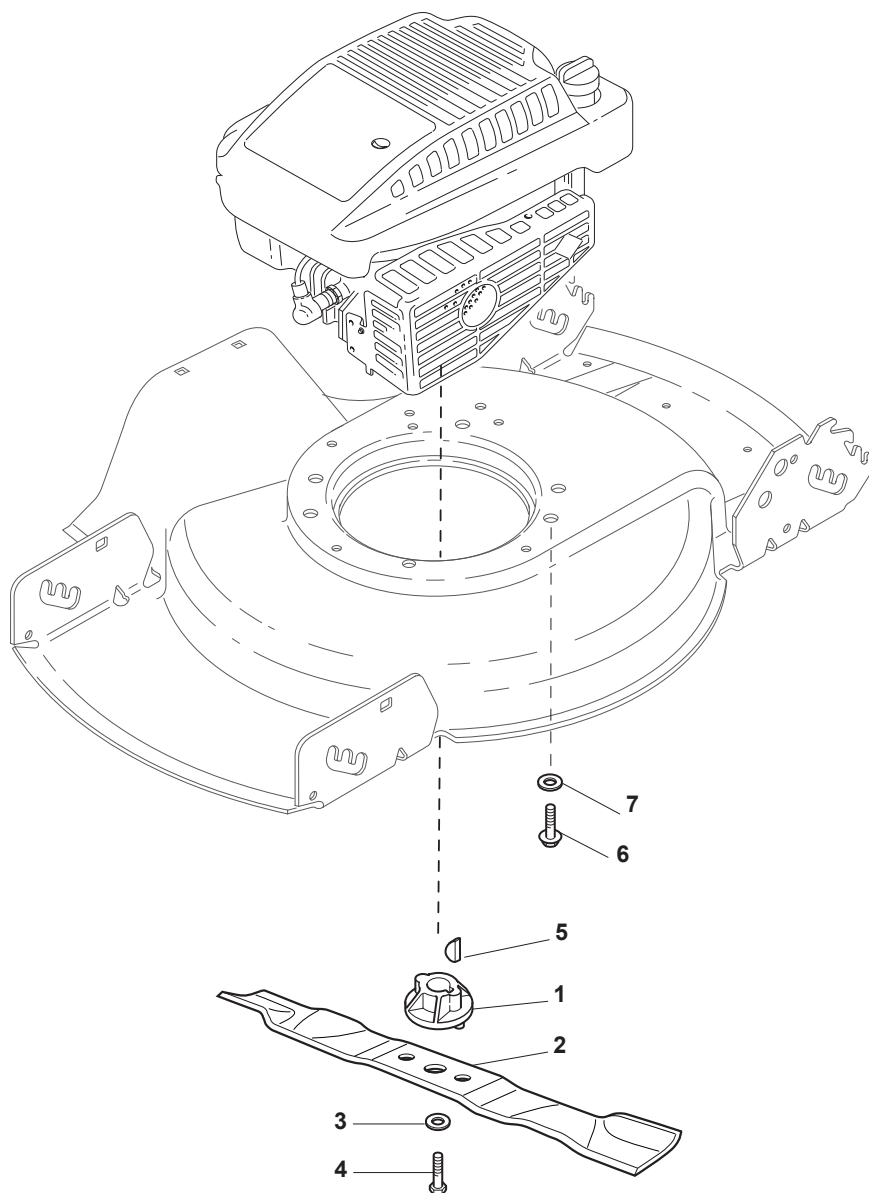

Utgåva Issue 39 - 2016		Kniv Blade			
Pos. Fig.	Antal Q.ty	Art nr Part No	Benämning	Description	Anmärkning Notes
1	1	122465617/0	Knivfäste	Hub	
2	1	181004124/1	Kniv	Blade Standard	
3	1	112530140/0	Bricka	Washer	
4	1	112735694/0	Skruv	Screw	
5	1	112139100/0	Kil	Key	
6	3	112735108/1	Skruv	Screw	
7	3	112521355/0	Bricka	Washer	

code	pos.	q.ty	page
112139100/0	5	1	p. 9
112154510/0	6	1	p. 5
112155000/0	12	4	p. 3
112361005/0	14	2	p. 3
112521350/0	16	2	p. 3
112521355/0	7	3	p. 9
112530140/0	3	1	p. 9
112727783/0	5	1	p. 5
112728691/0	39	1	p. 3
112735108/1	6	3	p. 9
112735694/0	4	1	p. 9
112793701/0	9	4	p. 3
112820655/0	18	2	p. 3
114367494/2	40	1	p. 3
122020050/0	10	4	p. 7
122122200/0	7	8	p. 7
122430215/0	12	4	p. 7
122430311/0	17	1	p. 3
122450441/0	3	2	p. 7
122450442/0	2	2	p. 7
122465617/0	1	1	p. 9
122671651/0	10	4	p. 3
122671654/0	4	4	p. 7
112521370/0	5	4	p. 7
181000685/0	3	1	p. 5
181004124/1	2	1	p. 9
322033395/0	1	2	p. 7
322041958/0	8	4	p. 3
322110491/0	11	4	p. 7
322192001/0	38	1	p. 3
322399810/0	15	2	p. 3
322545137/0	19	2	p. 3
322551577/0	11	2	p. 3
322551640/0	4	1	p. 5
322600095/0	6	4	p. 7
322600159/0	6	1	p. 3
322686091/1	8	4	p. 7
381003298/1	2	1	p. 5
381004733/0	1	1	p. 3
381006632/1	1	1	p. 5
381007548/0	13	1	p. 3
381008502/0	7	1	p. 3