



www.stiga.com

Illustrated Parts List

for model:

COMBI 48 SQ

- Use GLOBAL GARDEN PRODUCT genuine spare parts specified in the parts list for repair and/or replacement.
- Then contents described in the parts list may change due to improvement.
- The drawings of the spare part are only indicative and might not represent the part in question exactly.
- The indications "right" - "left" - "front" - "rear" refer to the position of the operator when using the machine.
- When placing orders of parts for repair and/or replacement, make sure that the illustrated parts list is the one applying to the machine's year of manufacture, as shown on the identification plate attached to the machine.

© Copyright 2014 Global Garden Products

All content is subject to copyright by Global Garden Products and may not be reproduced in whole or in part by any means, electronic or otherwise, without prior written approval.

THIS INFORMATION IS NOT INTENDED FOR SALE OR RESALE, AND THIS NOTICE MUST REMAIN ON ALL COPIES.

www.ggp-group.com



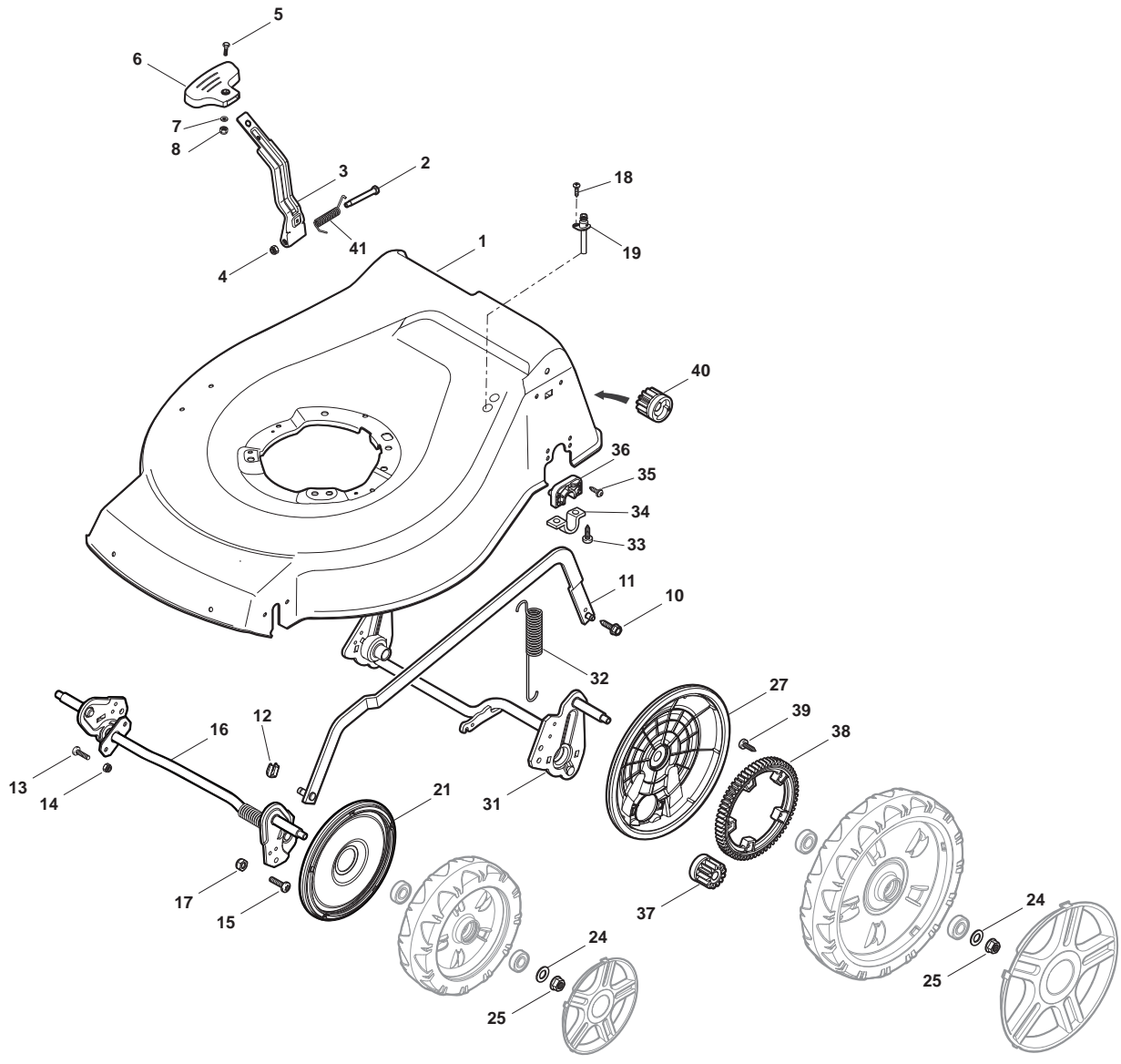

Deck And Height Adjusting				
POS	CODE	Q.TY	DESCRIPTION	NOTES
1	381004731/0	1	Deck Grey	
2	122534131/0	1	Pin	
3	381003398/0	1	Lever, Height Adjustment	
4	112154510/0	1	Nut	
5	112788512/0	1	Screw	
6	322394503/0	1	Knob	
7	112521310/0	1	Washer	
8	112150000/0	1	Nut	
10	122943013/0	1	Screw	
11	381002030/0	1	Rod, Height Adjustment	
12	112436051/0	1	Plate	
13	112727803/0	3	Screw	
14	112154510/0	3	Nut	
15	112727801/0	1	Screw	
16	381002883/1	1	Axle, Front Wheels	
17	112154510/0	1	Nut	
18	112728450/0	1	Screw	
19	322034002/0	1	Washing Connection	
21	322600145/0	2	Protection, Wheel	
24	112521350/0	4	Washer	
25	112155000/0	4	Nut	
27	322600208/0	2	Protection, Wheel	
31	381302835/1	1	Axle, Rear Wheels	
32	122450460/0	1	Spring	
33	112728697/0	4	Screw	
34	322545152/0	2	Plate	
35	112728697/0	4	Screw	
36	322785304/1	2	Support	
37	122570134/0	1	Pinion L	
38	322120115/0	2	Ring Gear	
39	112728706/0	6	Screw	
40	122570133/0	1	Pinion R	
41	122446192/0	1	Spring	

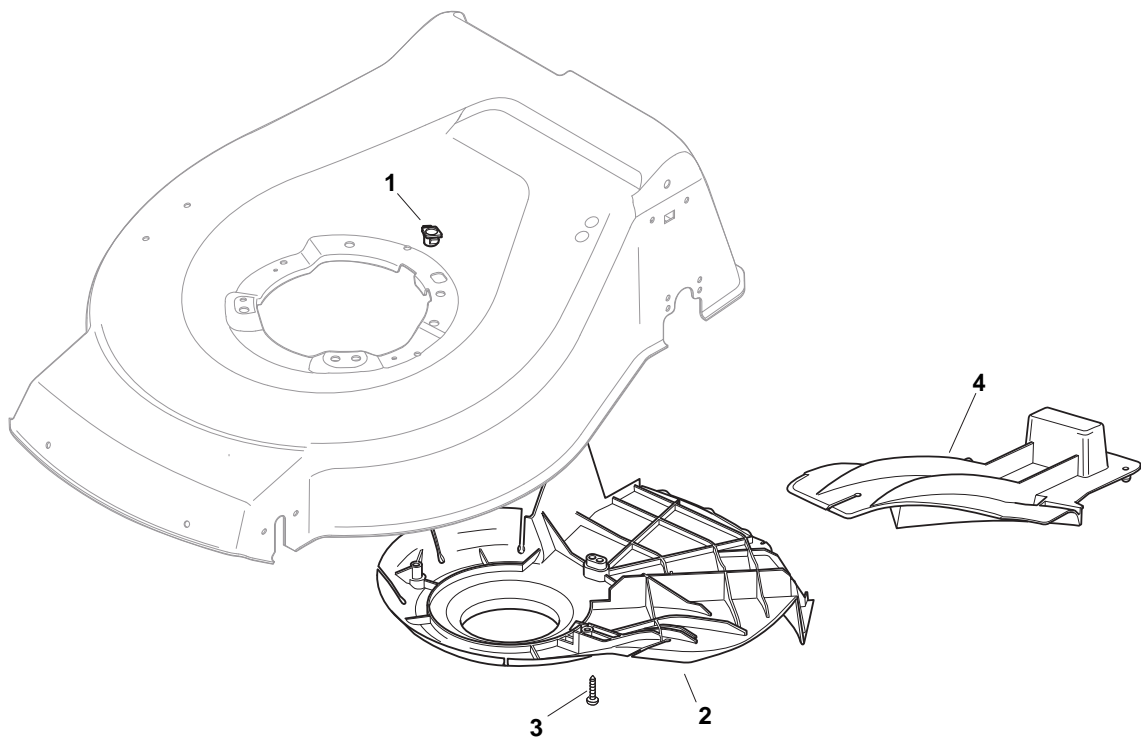

Mulching Kit				
POS	CODE	Q.TY	DESCRIPTION	NOTES
1	322291150/0	1	Rubber Insert	
2	322060198/1	1	Protection, Belt	
3	112728530/0	3	Screw	
4	322140223/0	1	Deflector	

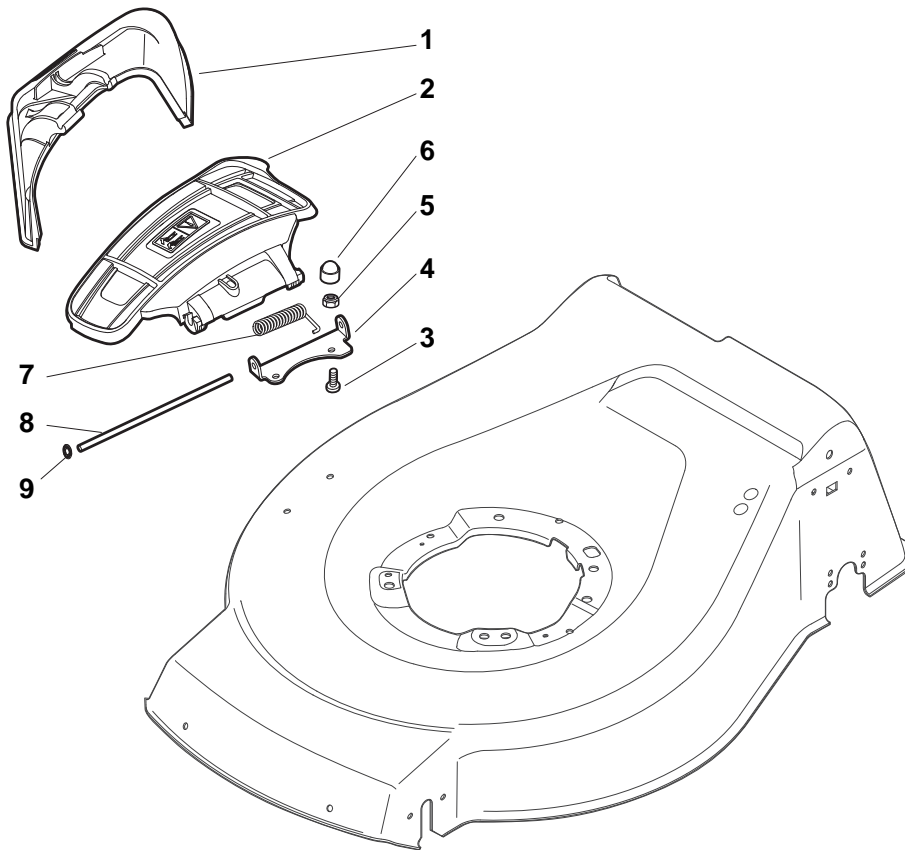

Side Discharge				
POS	CODE	Q.TY	DESCRIPTION	NOTES
1	322108295/0	1	Stone-Guard	
2	322600195/0	1	Ejection Guard	
3	112727803/0	2	Screw	
4	322806639/0	1	Fulcrum Pin	
5	112154510/0	2	Nut	
6	118203853/0	2	Protection	
7	122450456/0	1	Spring	
8	122517869/0	1	Pin	
9	112604896/0	2	Crown Fastener	

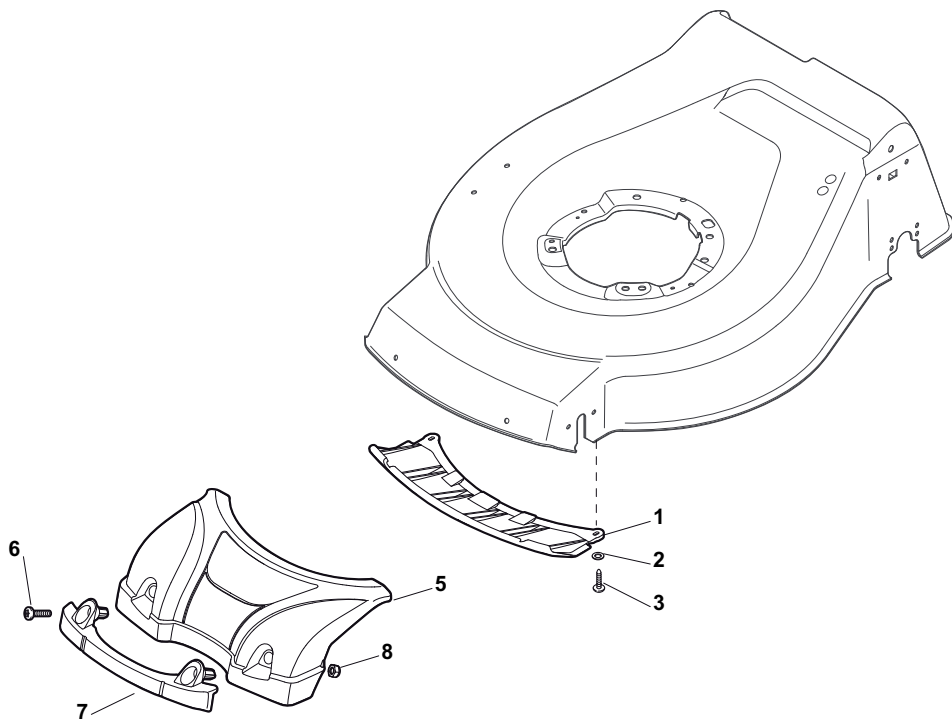

Mask				
POS	CODE	Q.TY	DESCRIPTION	NOTES
1	322500102/0	1	Front Combi	
2	112523000/1	2	Washer	
3	112728124/0	2	Screw	
5	322226195/0	1	Mask, Grey	
6	112727799/0	2	Screw	
7	322393639/0	1	Handle, Grey	
8	112154510/0	2	Nut	

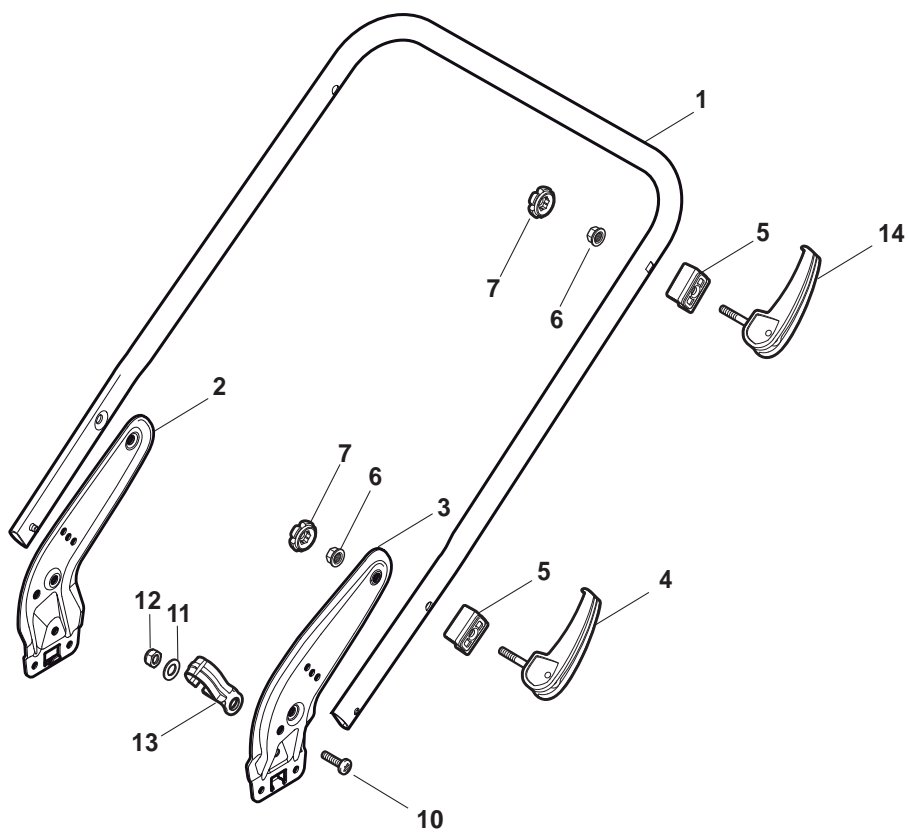

Handle, Lower Part (LUX Version)				
POS	CODE	Q.TY	DESCRIPTION	NOTES
1	381006720/0	1	Handle, Lower Part	
2	381005149/0	1	Bracket, R	
3	381005151/0	1	Bracket, L	
4	381003253/0	2	Handle	
5	322680016/0	4	Support	
6	122131750/0	4	Nut	
7	322399835/0	4	Knob	
10	112760605/0	2	Screw	
11	125038002/1	2	Bush	
12	112155000/0	2	Nut	
13	322192156/0	1	Fair Led	
14	381103350/0	2	Handle	

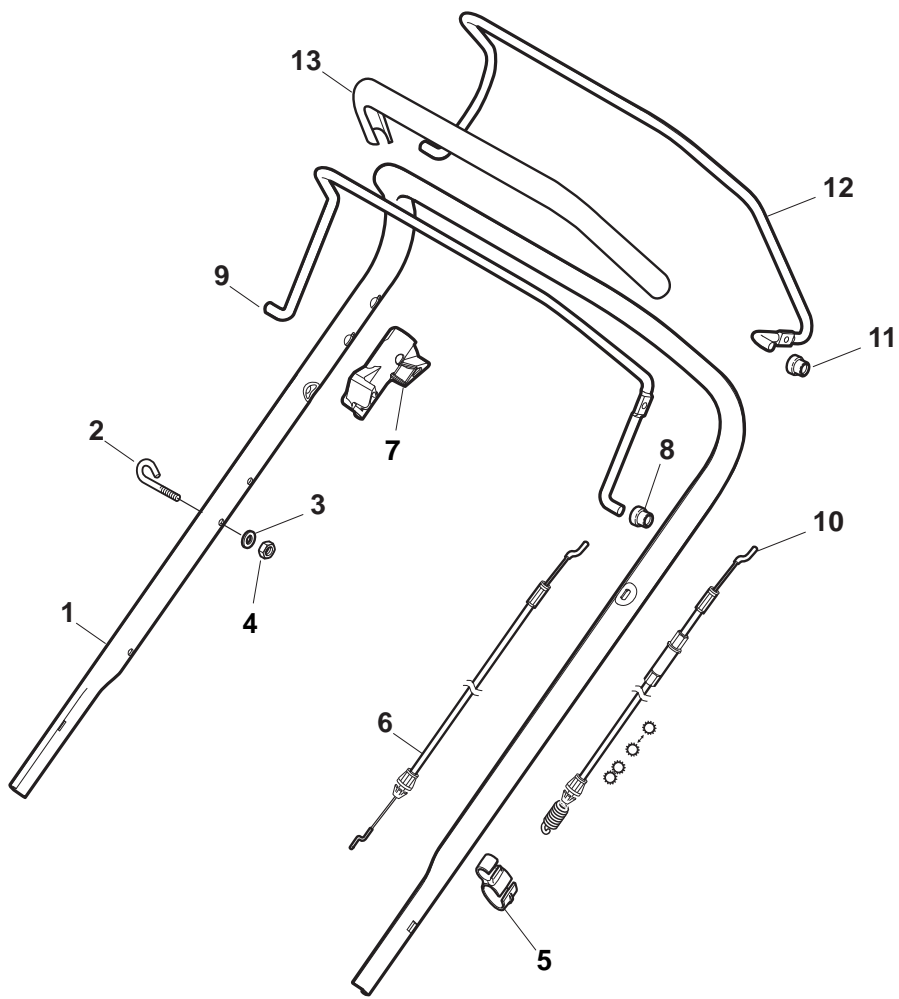

Handle, Upper Part (LUX Version)				
POS	CODE	Q.TY	DESCRIPTION	NOTES
1	381006838/0	1	Handle, Upper Part Black	
1	381007525/0	1	Handle, Upper Part Grey	
2	122430313/0	1	Guide Spring	
3	112521330/0	1	Washer	
4	112154510/0	1	Nut	
5	118390020/0	1	Fairlead	
6	181030053/0	1	Cable, Thread Engine Brake	
7	322545204/0	1	Fulcrum Pin	
8	122041966/0	1	Bush	
9	181003300/1	1	Lever, Engine Brake	
10	381030092/0	1	Cable, Rear Drive	
11	122041966/0	1	Bush	
12	181003301/0	1	Lever, Driving	
13	122291050/0	1	Handgrip Black	

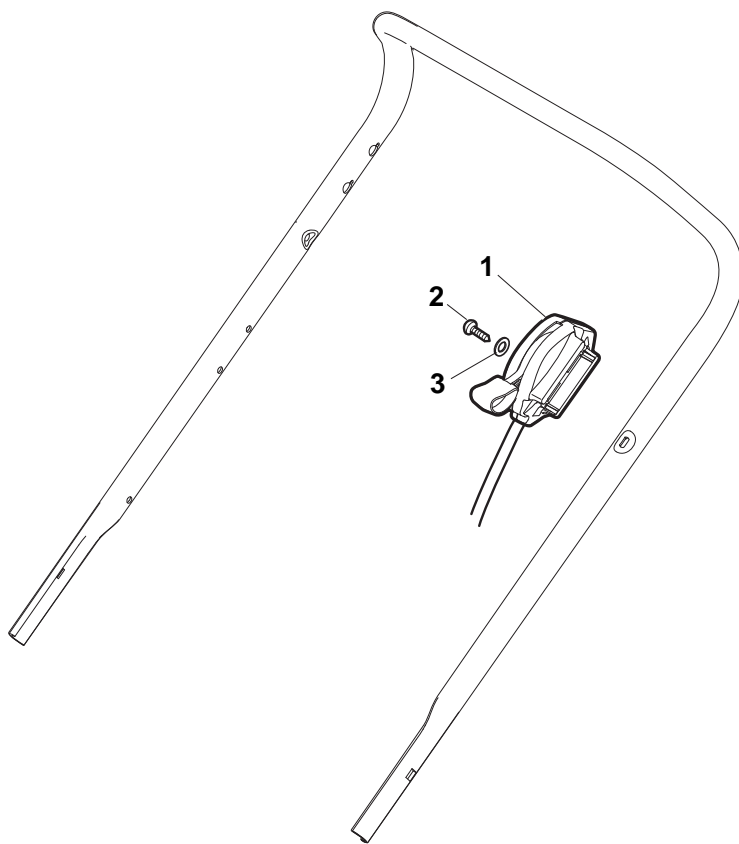

Throttle				
POS	CODE	Q.TY	DESCRIPTION	NOTES
1	181005501/1	1	Throttle Cable	
2	112735103/0	1	Screw	
3	112523040/0	1	Washer	

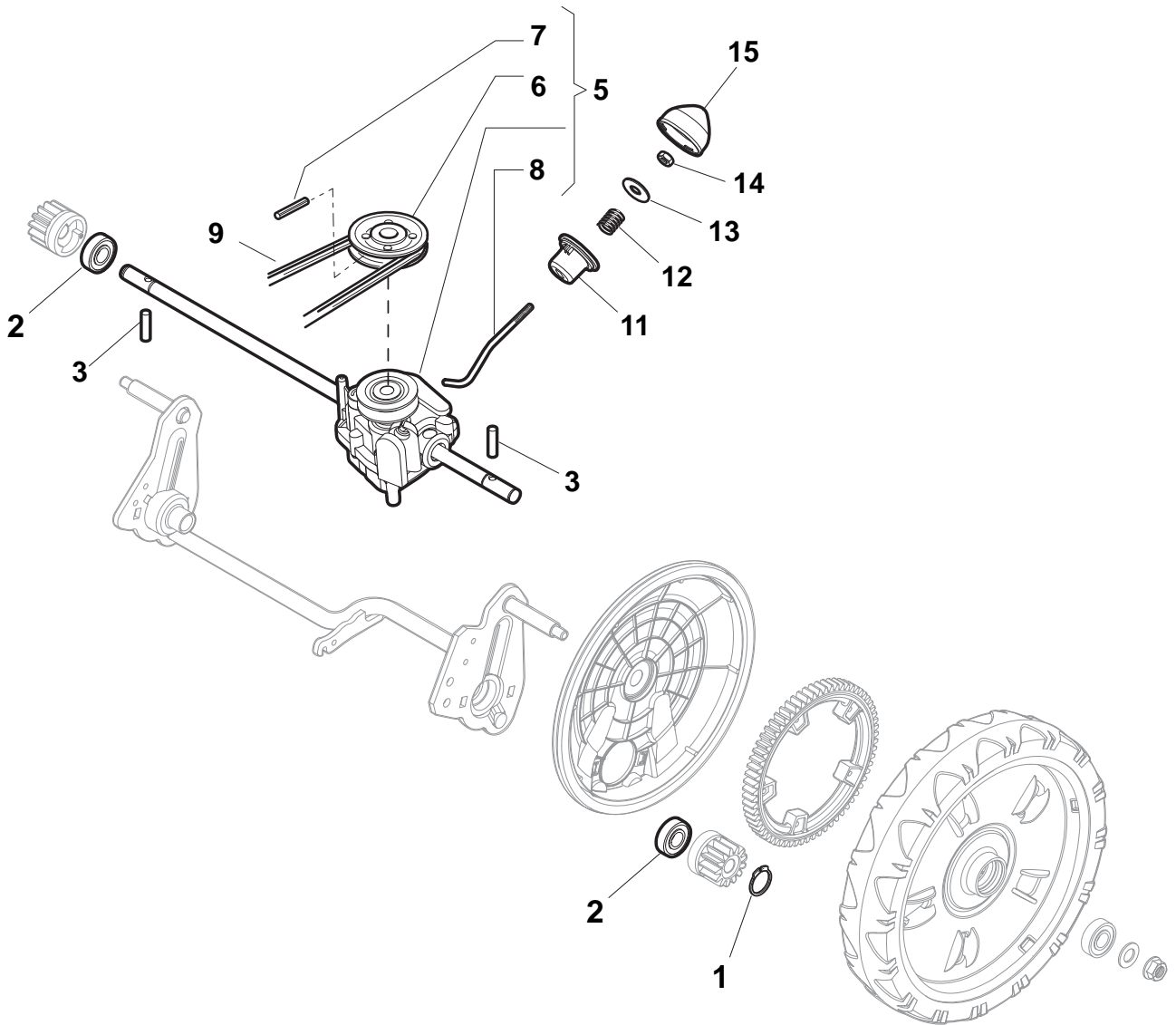

Rear Drive				
POS	CODE	Q.TY	DESCRIPTION	NOTES
1	112608600/0	2	Seeger	
2	119216035/0	2	Bearing	
3	122753000/0	2	Pin	
5	181003076/1	1	Gear Box G.T. Cone Clutch	
6	122601904/0	1	Pulley	
7	112645705/0	1	Pin	
8	122033283/0	1	Adjustment Rod	
9	135063800/0	1	Belt	
11	122041957/1	1	Bush	
12	122450063/0	1	Spring	
13	322680009/0	1	Washer	
14	112154510/0	1	Nut	
15	122110230/0	1	Cap	

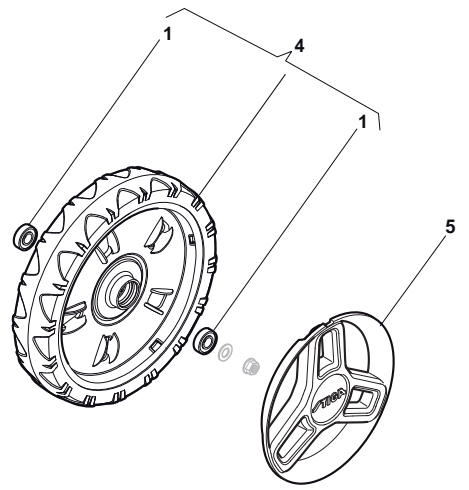
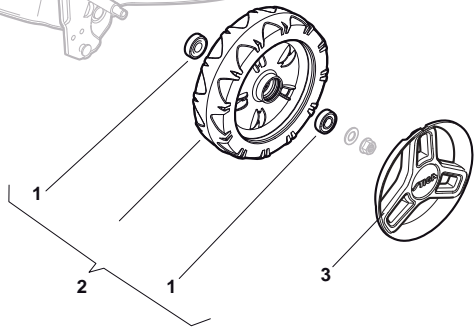
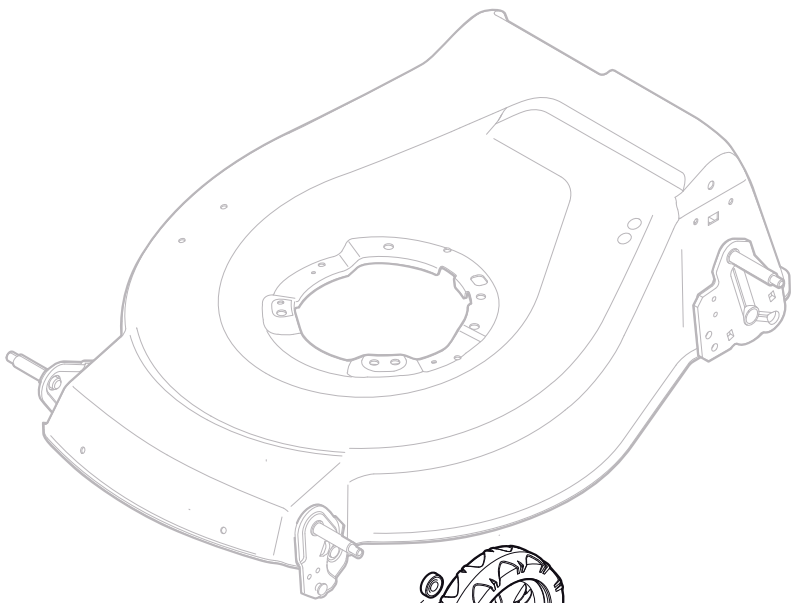

NT Wheels with Bearing				
POS	CODE	Q.TY	DESCRIPTION	NOTES
1	119216035/0	8	Bearing	
2	381007416/2	4	Wheel Ø 200	
3	322110744/0	2	Hub Cap Grey	
4	381007417/2	2	Wheel Ø 280	
5	322110745/0	2	Hub Cap Grey	

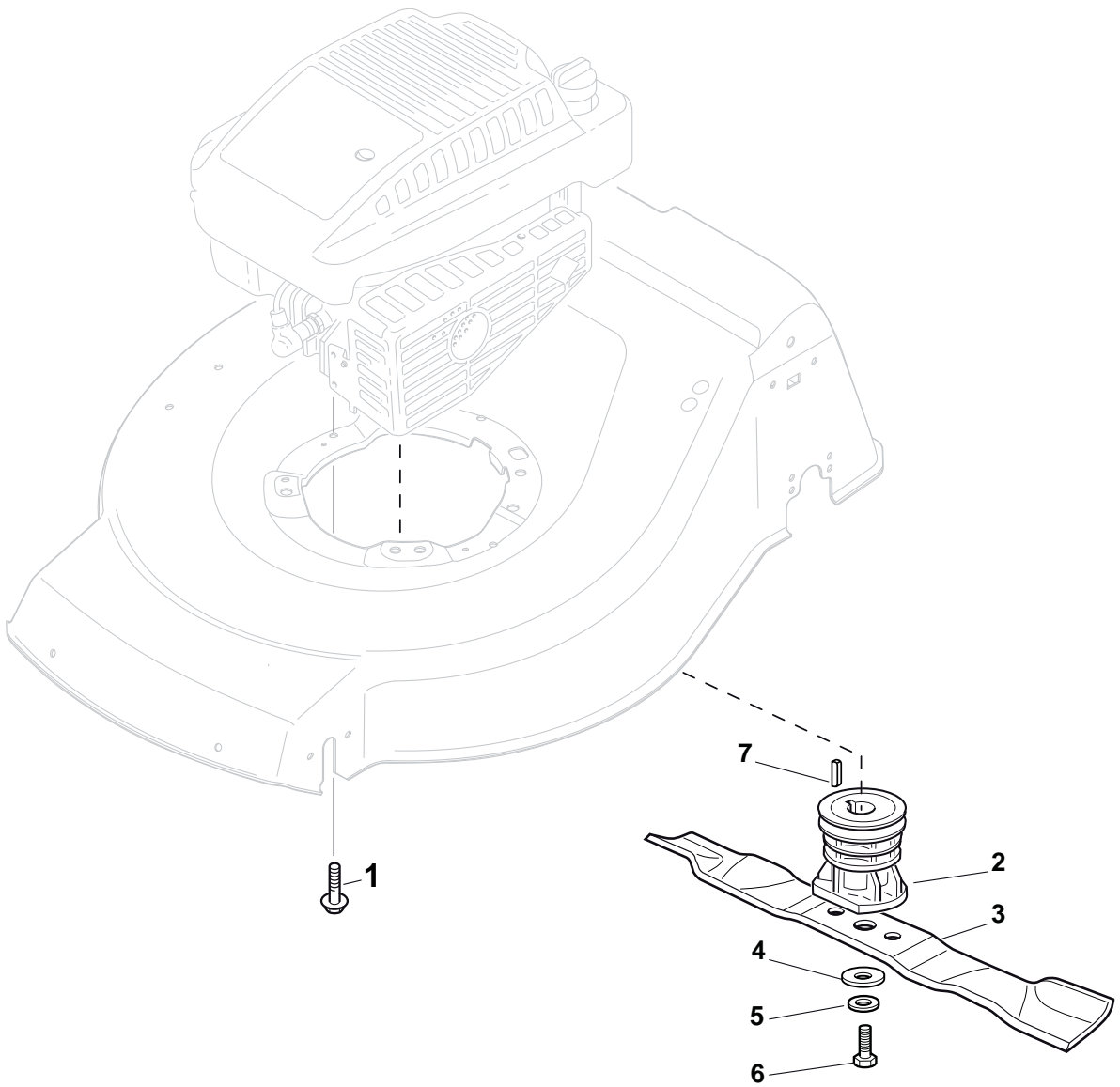

Blade				
POS	CODE	Q.TY	DESCRIPTION	NOTES
1	112735108/1	3	Screw	
2	122465607/3	1	Hub With Pulley, Crankshaft Ø 22.2	
3	181004458/0	1	Blade Standard	
4	122160400/0	1	Elastic Washer	
5	112523080/0	1	Washer	
6	112735698/0	1	Screw	
7	112139100/0	1	Feather, Crankshaft Ø 22.2	

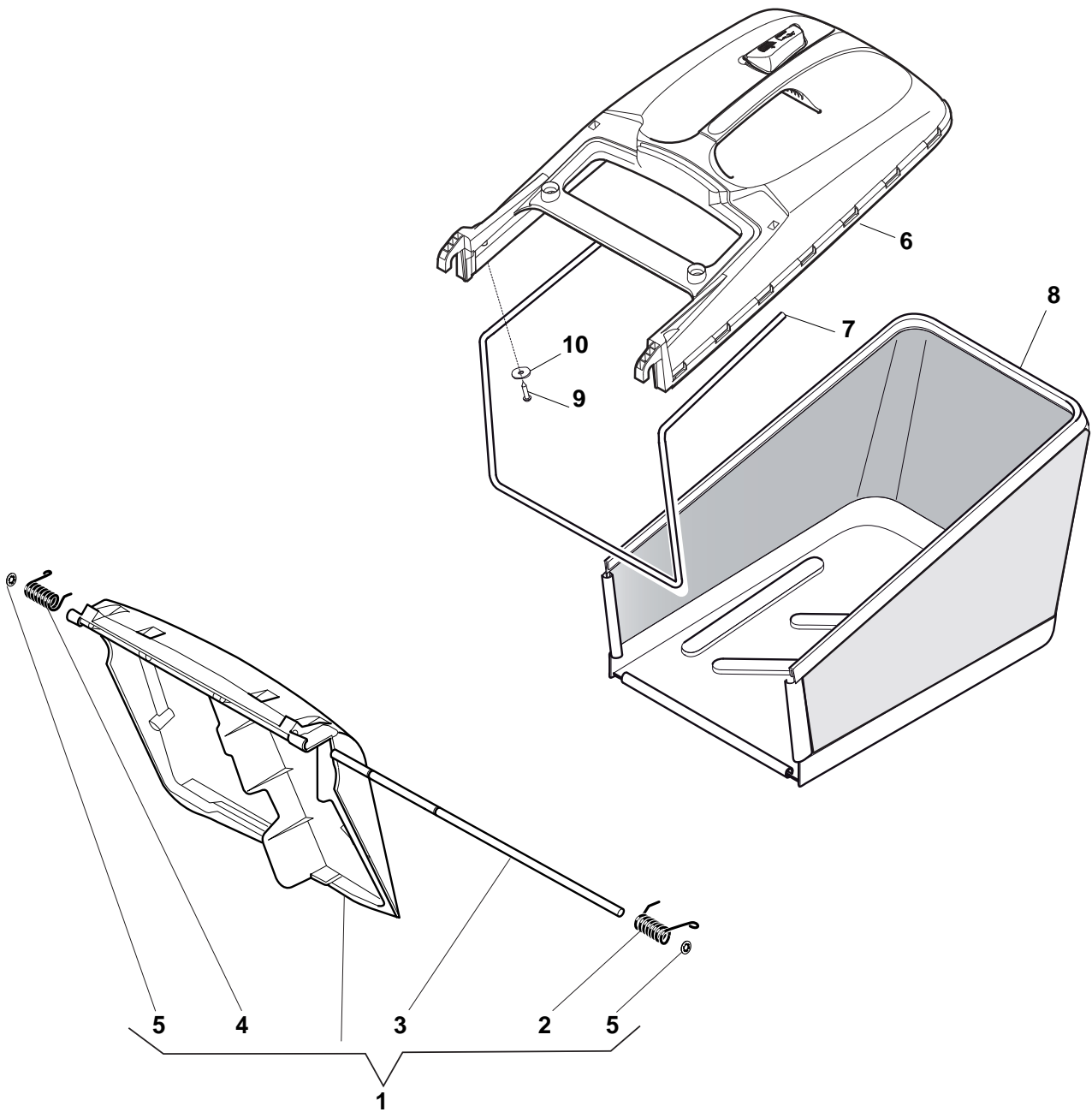

Hybrid Grass-Catcher				
POS	CODE	Q.TY	DESCRIPTION	NOTES
1	381008082/2	1	Stone-Guard Yellow	
2	122450466/0	1	L Spring	
3	122517882/0	1	Pin	
4	122450465/0	1	R Spring	
5	112604899/0	2	Crown Fastener	
6	381486012/0	6	Grass-Box, Upper Part	
7	122608525/1	1	Stiffening Lower	
8	181002211/0	1	Box, Fabric	
9	112728680/0	2	Screw	
10	112523050/0	2	Washer	