

Genuine Spare Parts

www.stiga.com

TURBO PRO 55 S4 B

- Use GLOBAL GARDEN PRODUCT Genuine Spare Parts specified in the parts list for repair and/or replacement.
- The contents described in the parts list may change due to improvement.
- The drawings of the spare parts are only indicative and might not represent the part in question exactly.
- The indications "right" - "left" - "front" - "rear" refer to the position of the operator when using the machine.
- When placing orders of parts for repair and/or replacement, make sure that the illustrated parts list is the one applying to the machine's year of manufacture, as shown on the identification plate attached to the machine.

© Copyright 2013 Global Garden Products

All content is subject to copyright by Global Garden Products and may not be reproduced in whole or in part by any means, electronic or otherwise, without prior written approval.

THIS INFORMATION IS NOT INTENDED FOR SALE OR RESALE, AND THIS NOTICE MUST REMAIN ON ALL COPIES.



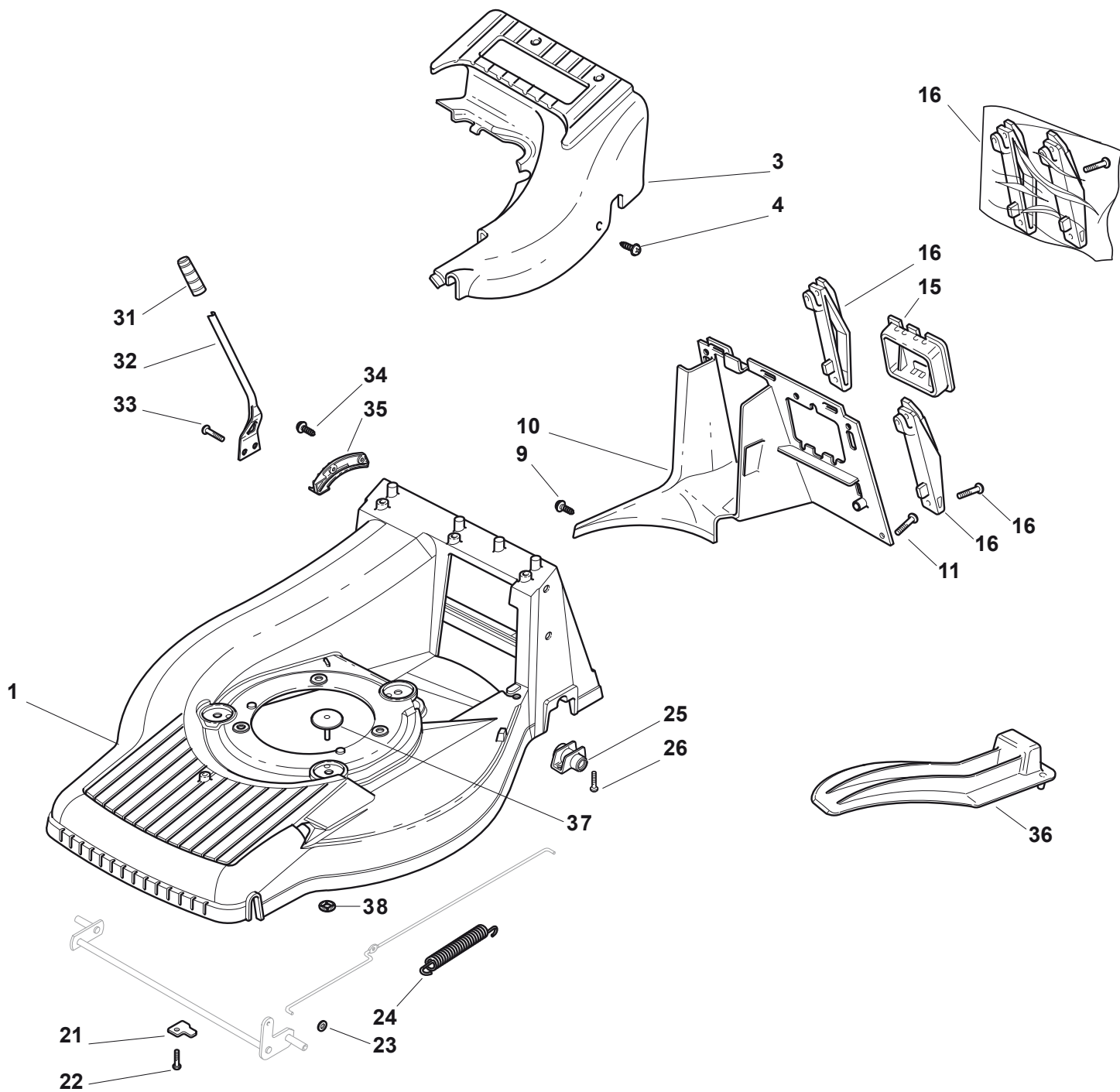

POSITION	PART No.	Q.Ty	DESCRIPTION	NOTES
1	381002660/0	1	Deck Yellow	
3	322060154/0	1	Protection, Yellow	
3	322060155/1	1	Protection, Red	
4	112728300/0	3	Screw	
9	112728300/0	1	Screw	
10	322108277/0	1	Rear Conveyor Assy	
11	112735664/0	3	Screw	
15	322109531/0	1	Cover	
16	381008658/1	1	Outfit, Supports	
21	322545160/0	2	Plate	
22	112735664/0	2	Screw	
23	112604898/0	2	Crown Fastener	
24	122446181/0	1	Spring	
25	322785153/0	2	Support, Gear Box	
26	112735664/0	4	Screw	
31	322399808/0	1	Knob	
32	322321515/0	1	Lever, Height Adjustment	
33	112735661/0	2	Screw	
34	112728300/0	2	Screw	
35	322735563/0	1	Sector, Height Adjustment	
36	322140232/0	1	Deflector	
37	322820055/0	1	Cap Yellow	
38	112604899/0	1	Crown Fastener	

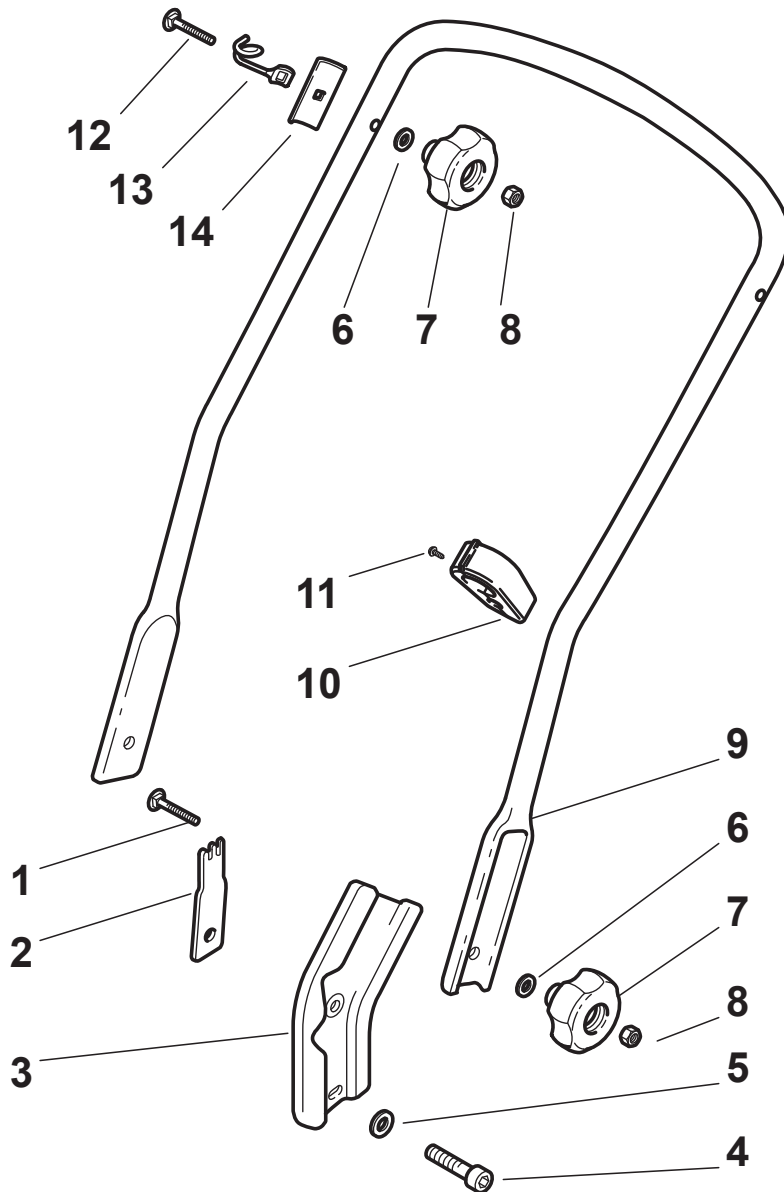

POSITION	PART No.	Q.Ty	DESCRIPTION	NOTES
1	112820655/0	2	Screw	
2	322551635/0	1	Plate For Handle	
3	322778405/0	2	Support	
4	112760515/0	2	Screw	
5	112521350/0	2	Washer	
6	112521350/0	4	Washer	
7	322399810/0	4	Knob	
8	112361005/0	4	Nut	
9	381006631/0	1	Handle, Lower Part	
10	322192001/0	1	Anchor Clamp	
11	112728691/0	1	Screw	
12	112820655/0	2	Screw	
13	122430311/0	1	Guide Spring	
14	322545137/0	2	Plate For Handle Fastening	

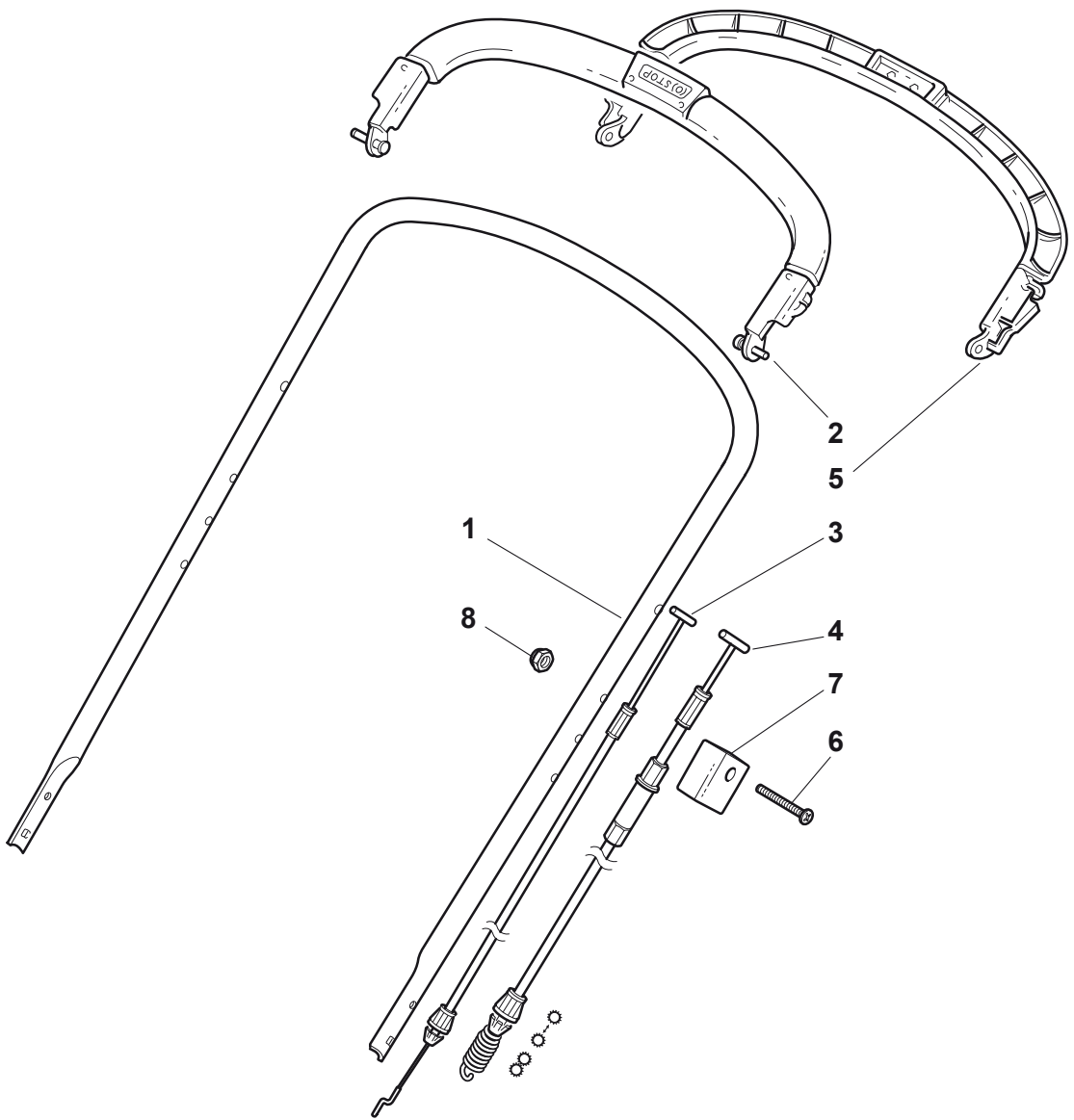

POSITION	PART No.	Q.Ty	DESCRIPTION	NOTES
1	381006632/1	1	Handle, Upper Part	
2	381003330/0	1	Lever, Engine Brake	
3	181030061/0	1	Cable, Thread Engine Brake	
4	381000697/0	1	Cable, Rear Drive	
5	381003297/1	1	Driving Lever	
6	112727783/0	1	Screw	
7	322551640/0	1	Plate	
8	112154510/0	1	Nut	

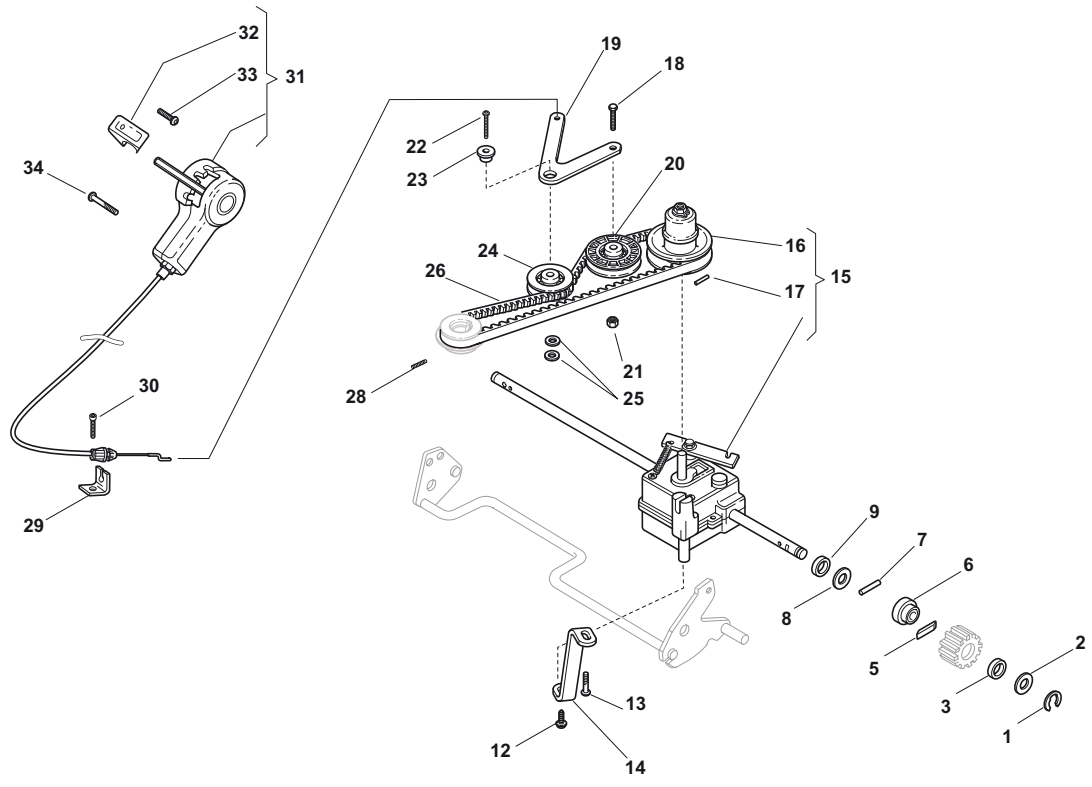

POSITION	PART No.	Q.Ty	DESCRIPTION	NOTES
1	112000957/0	2	Snap Ring	
2	112520032/0	2	Washer	
3	322160520/0	2	Dust Cover	
5	122076645/0	2	Key	
6	322170630/0	2	Spacer	
7	122753002/0	2	Pin	
8	112520032/0	2	Washer	
9	119035152/0	2	Or Ring	
12	112728300/0	1	Screw	
13	112735664/0	1	Screw	
14	322778407/0	1	Support	
15	181003086/0	1	Gear Box	
16	122601916/0	1	Pulley	
17	112645700/0	1	Pin	
18	112674550/0	1	Screw	
19	322320003/0	1	Driving Lever	
20	122601914/0	1	Pulley	
21	112154510/0	1	Nut	
22	112735669/0	1	Screw	
23	122671656/0	1	Washer	
24	122601915/0	1	Pulley	
25	112523040/0	2	Washer	
26	135064383/0	1	Belt	
28	112714312/0	1	Dowel	
29	322806619/0	1	Support	
30	112735664/0	1	Screw	
31	381007098/0	1	Cable, Speed Drive Control	
32	322399809/0	1	Knob	
33	112728300/0	2	Screw	
34	112728702/0	2	Screw	

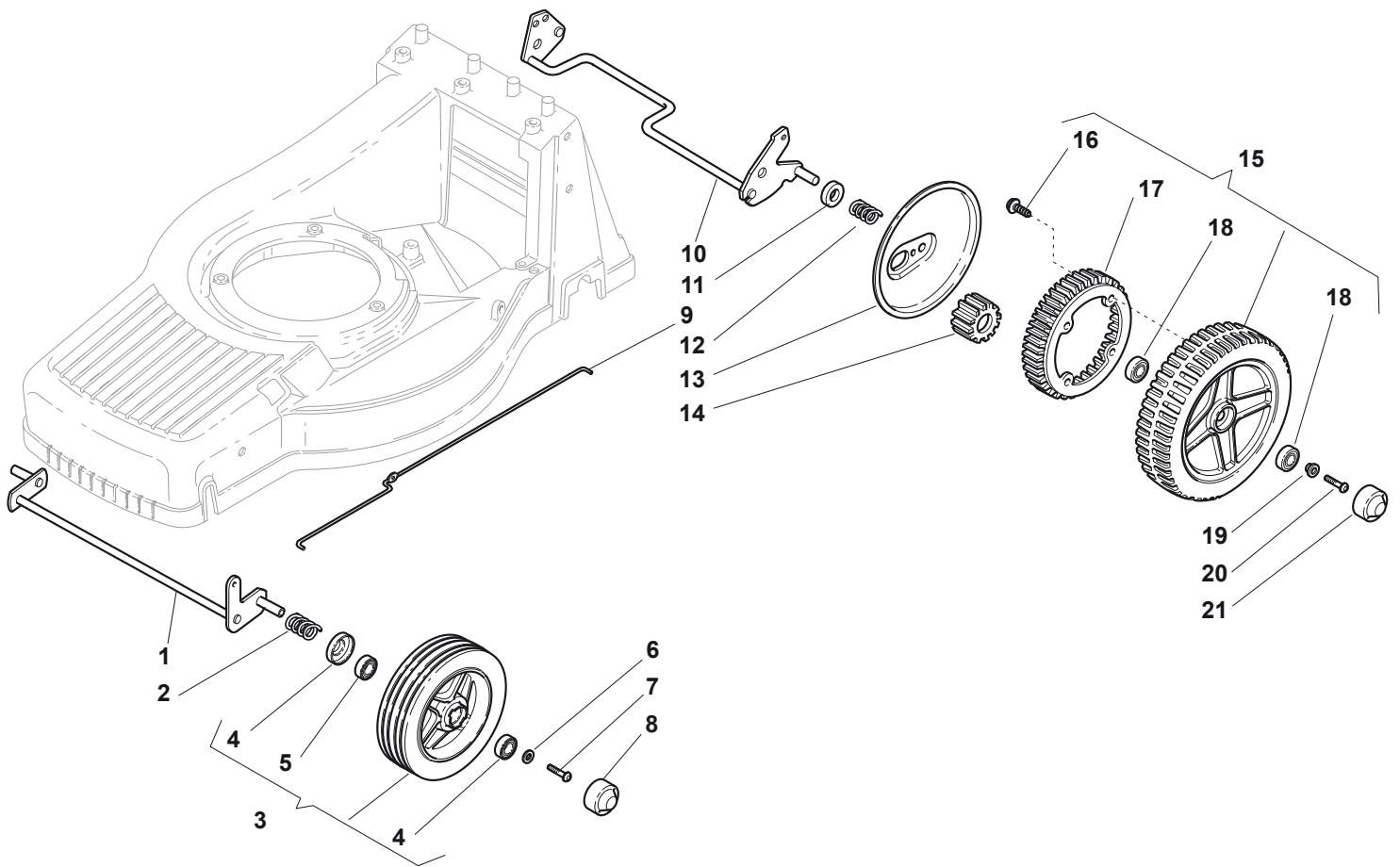

POSITION	PART No.	Q.Ty	DESCRIPTION	NOTES
1	381002825/0	1	Axle, Front Wheels	
2	122430210/0	2	Spring	
3	381007364/0	2	Wheel Ø 190	
4	322160522/0	2	Dust Cover	
5	119216039/0	4	Bearing	
6	112521460/0	2	Washer	
7	112735662/1	2	Screw	
8	322110379/0	2	Hub Cap	
9	122033324/0	1	Rod, Height Adjustment Control	
11	122170810/0	2	Spacer	
12	122430215/0	2	Spring	
13	322600127/0	2	Protection, Wheel	
14	122570126/0	2	Pinion	
15	381007368/0	2	Wheel Ø 215	
16	112728210/0	8	Screw	
17	322120108/0	2	Ring Gear	
18	119216038/0	4	Bearing	
19	122671655/0	2	Washer	
20	112735592/0	2	Screw	
21	322110380/0	2	Hub Cap	

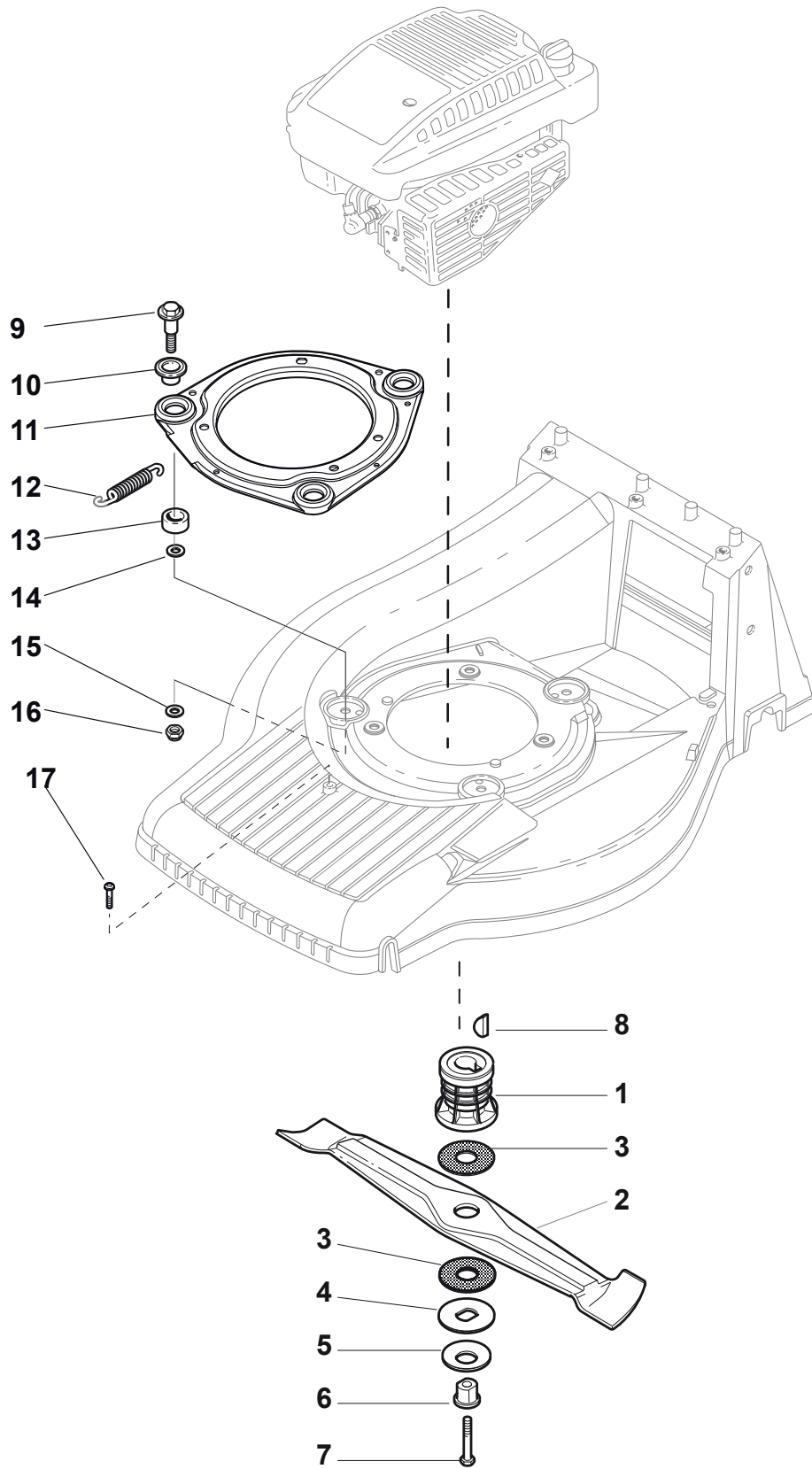

POSITION	PART No.	Q.Ty	DESCRIPTION	NOTES
1	122465636/0	1	Hub With Pulley, Crankshaft Ø 22.2	
2	181004134/0	1	Blade Winged	
3	322672111/0	2	Clutch Washer	
4	322672105/0	1	Washer	
5	112508120/0	1	Cupped Spring	
6	122041940/0	1	Clutch Bush	
7	112736825/0	1	Screw	
8	112139100/0	1	Feather, Crankshaft Ø 22.2	
9	122524329/0	3	Pin	
10	322672201/0	3	Washer	
11	322207225/0	1	Flange, Black	
12	122450445/0	1	Spring	
13	322250012/0	3	Grommet	
14	122671651/0	3	Washer	
15	112523060/0	3	Washer	
16	112155000/0	3	Nut	
17	112735661/0	1	Screw	

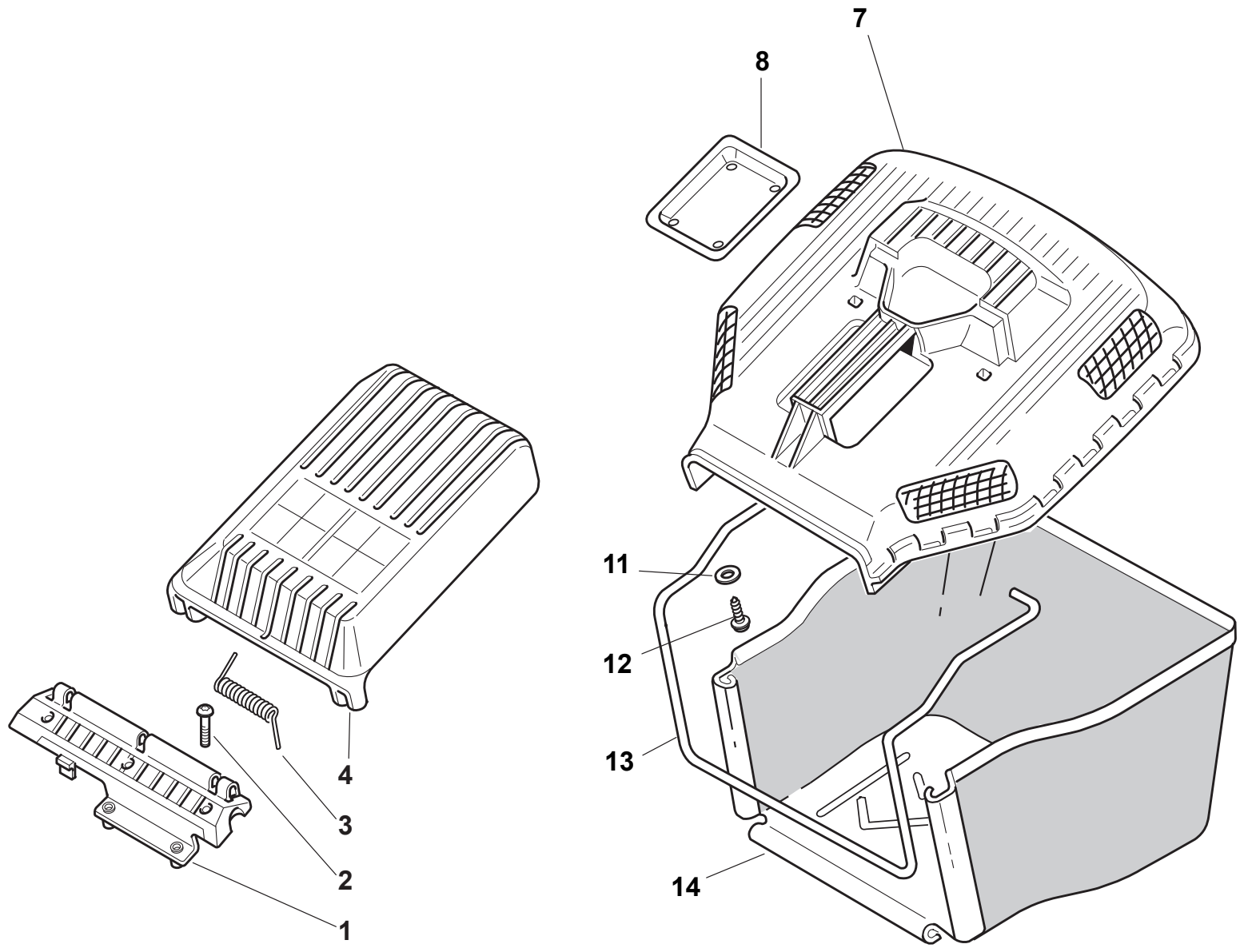

POSITION	PART No.	Q.Ty	DESCRIPTION	NOTES
1	322785157/0	1	Support, Yellow	
2	112735664/0	3	Screw	
3	122450430/0	1	Spring	
4	322600069/2	1	Stone-Guard, Yellow	
7	322486095/0	1	Grass-Box, Upper Part	
8	322486098/0	1	Plate	
11	112521460/0	2	Washer	
12	112728300/0	2	Screw	
13	122608528/0	1	Stiffening Lower	
14	181002235/0	1	Box, Fabric	