

Genuine Spare Parts

www.stiga.com

EXCEL 50 S4Q INOX B

- Use GLOBAL GARDEN PRODUCT Genuine Spare Parts specified in the parts list for repair and/or replacement.
- The contents described in the parts list may change due to improvement.
- The drawings of the spare parts are only indicative and might not represent the part in question exactly.
- The indications "right" - "left" - "front" - "rear" refer to the position of the operator when using the machine.
- When placing orders of parts for repair and/or replacement, make sure that the illustrated parts list is the one applying to the machine's year of manufacture, as shown on the identification plate attached to the machine.

© Copyright 2013 Global Garden Products

All content is subject to copyright by Global Garden Products and may not be reproduced in whole or in part by any means, electronic or otherwise, without prior written approval.

THIS INFORMATION IS NOT INTENDED FOR SALE OR RESALE, AND THIS NOTICE MUST REMAIN ON ALL COPIES.



POSITION	PART No.	Q.Ty	DESCRIPTION	NOTES
1	322064706/0	1	Deck INOX	
2	322034001/1	1	Washing Connection	
3	125943004/0	5	Screw	
4	112815200/0	2	Screw	
5	322108297/0	1	Conveyor Yellow	
6	112437507/0	12	Plate	
7	112727802/0	8	Screw	
8	381545321/0	1	Rear Plate	
9	322785282/0	1	Support	
10	381545327/0	1	Bracket, L	
11	322545191/0	1	Support	
12	112727803/0	2	Screw	
13	112154510/0	4	Nut	
14	112521330/0	1	Washer	
15	112815200/0	1	Screw	
16	112818690/0	4	Screw	
17	112521350/0	4	Washer	
18	112155000/0	4	Nut	
19	112727801/0	2	Screw	
21	381545325/0	1	Bracket, R	
22	112735662/1	2	Screw	
23	122534128/0	2	Pin	
25	381393701/0	2	Protection	
26	112815205/0	2	Screw	
27	112154510/0	2	Nut	
28	381102202/0	1	Protection Mulching	
29	125943004/0	2	Screw	
30	112735115/0	3	Screw	
31	322500052/1	1	Shoe	
32	112731580/0	2	Screw	
33	112521331/0	2	Washer	
34	381003338/0	1	Lever	
35	321660100/0	1	Washer	
36	112521370/0	1	Washer	
37	112293201/0	1	Nut	
38	322320009/0	1	Lever	
39	122042022/0	1	Bush	
40	125943004/0	3	Screw	
41	322109826/0	1	Guard Black	
42	322109825/0	1	Guard Black	
45	322500100/0	1	Front Combi	
46	112728706/0	6	Screw	
48	322226138/0	1	Mask, Black	
49	112727801/0	2	Screw	
50	112815270/0	2	Screw	
51	122671664/0	2	Spacer	
52	112540040/0	2	Washer	
53	325160039/0	6	Spacer	
54	112794986/0	1	Screw	
55	112727799/0	2	Screw	
56	112521350/0	1	Washer	
57	112155000/0	1	Nut	
58	381608501/0	1	Stiffening Lower	
59	118203853/0	1	Protection	

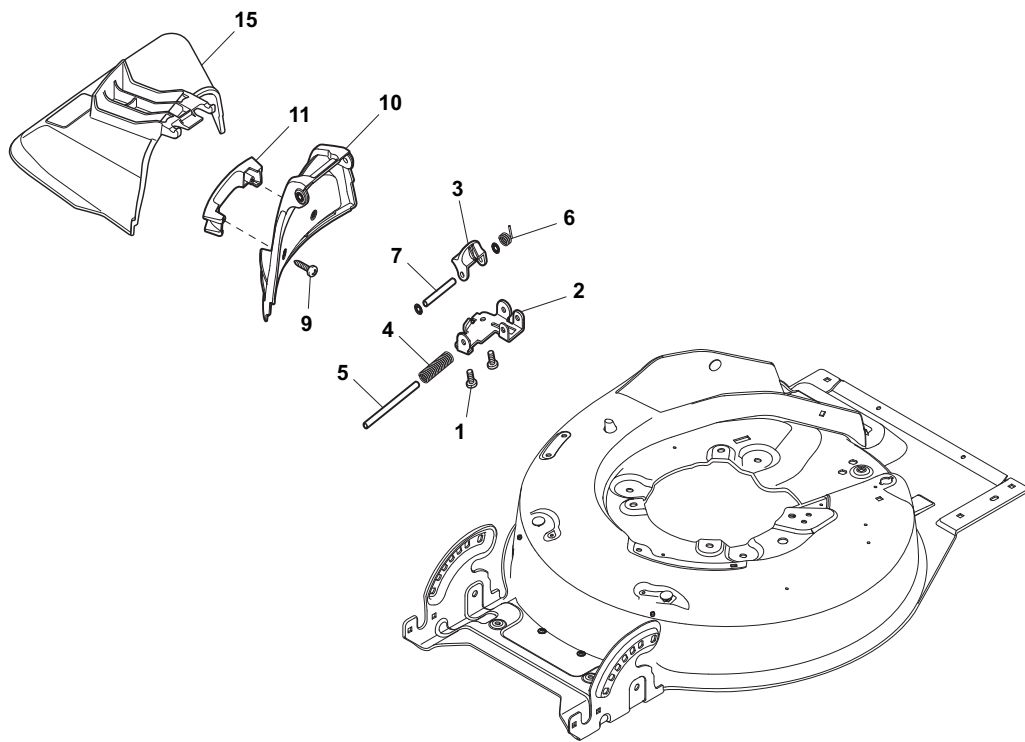

POSITION	PART No.	Q.Ty	DESCRIPTION	NOTES
1	112727803/0	2	Screw	
2	322806635/1	1	Fulcrum Pin	
3	322783010/1	1	Button	
4	122450456/0	1	Spring	
5	122517864/0	1	Pin	
6	122450457/0	1	Spring	
7	122517866/0	1	Pin	
9	112728706/0	2	Screw	
10	322600200/0	1	Ejection Guard	
11	322393633/0	1	Handle	
15	322108289/0	1	Ejection Guard	

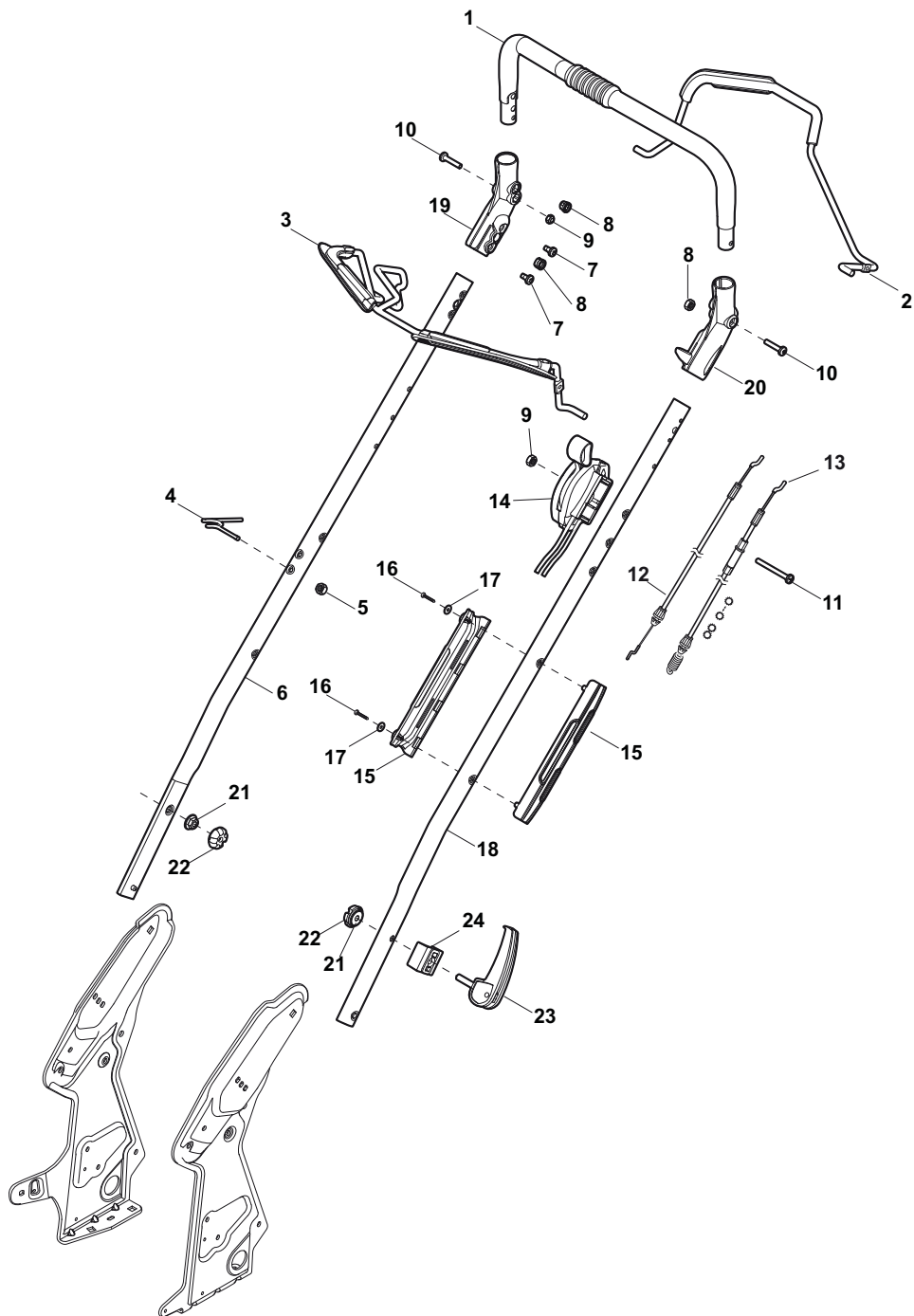

POSITION	PART No.	Q.Ty	DESCRIPTION	NOTES
1	381006670/2	1	Handgrip	
2	381003349/0	1	Lever, Driving	
3	381003344/0	1	Lever, Engine Brake	
4	122430309/0	1	Spring	
5	112154330/0	1	Nut	
6	381006895/0	1	Handle Black, R	
7	112735662/1	4	Screw	
8	322041967/1	4	Bush	
9	112154510/0	3	Nut	
10	112728721/0	2	Screw	
11	112727786/0	1	Screw	
12	181030065/0	1	Cable, Thread Engine Brake	
13	381030067/0	1	Cable, Rear Drive	
14	181005520/1	1	Throttle Cable	
15	322806644/0	1	Protection	
16	112727812/0	2	Screw	
17	112523000/1	2	Washer	
18	381006897/0	1	Handle Black, L	
19	322488301/0	1	Support , R	
20	322488303/0	1	Support, L	
21	112154220/0	2	Nut	
22	322399835/0	2	Knob	
23	381003253/0	2	Handle	
24	322680017/0	2	Support	

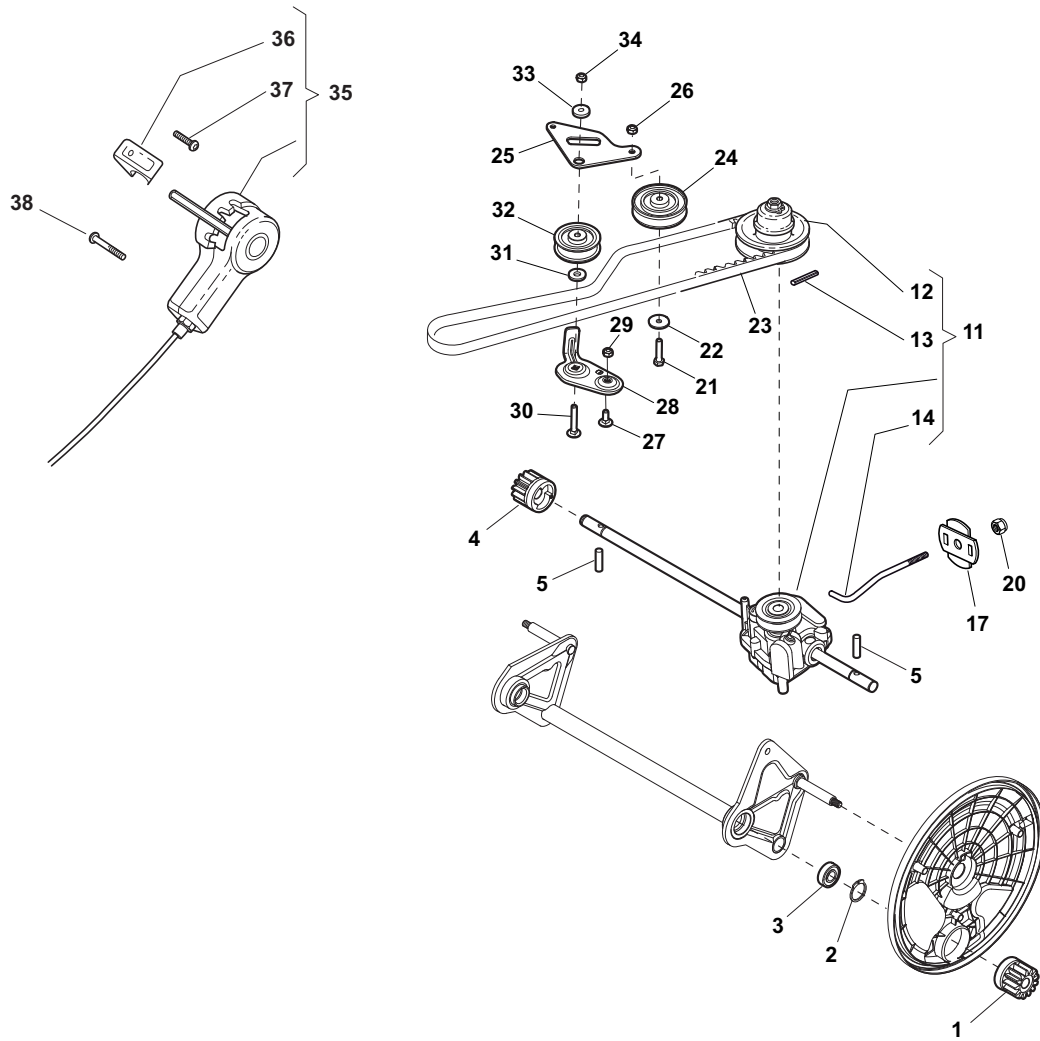

POSITION	PART No.	Q.Ty	DESCRIPTION	NOTES
1	122570132/0	1	Pinion L	
2	112608600/0	4	Seeger	
3	119216035/0	2	Bearing	
4	122570131/0	1	Pinion R	
5	122753000/0	2	Pin	
11	181003107/1	1	Gear Box	
12	122601925/0	1	Pulley	
13	112645700/0	1	Pin	
14	122033298/0	1	Adjustment Rod	
17	322675113/0	2	Washer	
20	112154510/0	1	Nut	
21	112674550/0	1	Screw	
22	112523050/0	1	Washer	
23	135064385/0	1	Belt	
24	122601914/0	1	Pulley	
25	322322835/0	1	Lever	
26	112154510/0	1	Nut	
27	112815205/0	1	Screw	
28	322806637/1	1	Support	
29	112154510/0	1	Nut	
30	112815240/0	1	Screw	
31	122671653/0	1	Washer	
32	122601915/0	1	Pulley	
33	122671656/0	1	Washer	
34	112154510/0	1	Nut	
35	381007189/0	1	Cable, Speed Drive Control	
36	322399820/0	1	Knob	
37	112728702/0	2	Screw	
38	112728536/0	2	Screw	

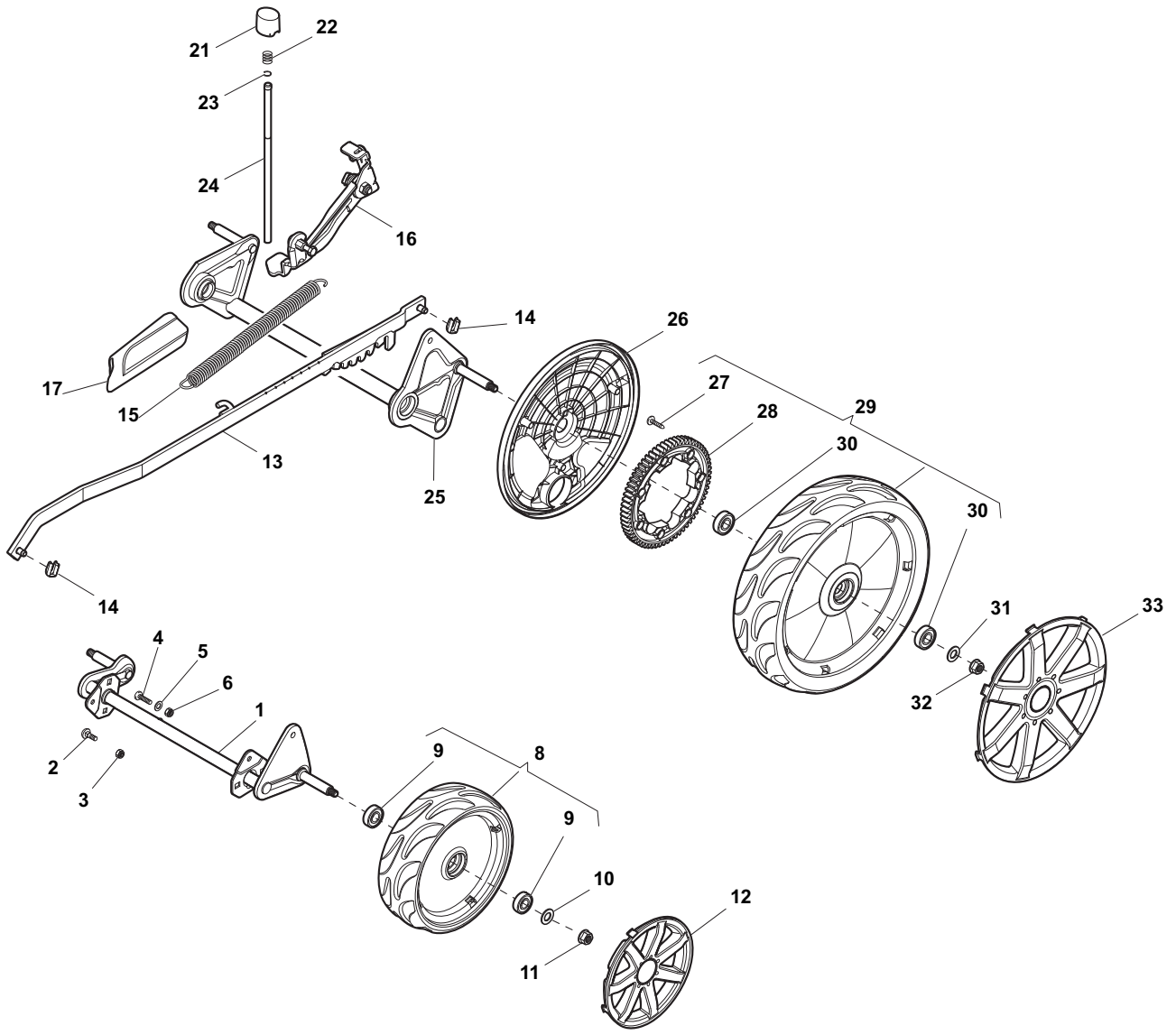

POSITION	PART No.	Q.Ty	DESCRIPTION	NOTES
1	381002869/1	1	Axle, Front Wheels	
2	112815205/0	4	Screw	
3	112154510/0	4	Nut	
4	112727799/0	2	Screw	
5	112523040/0	2	Washer	
6	112154510/0	2	Nut	
8	381007394/1	2	Wheel Ø 210	
9	119216035/0	4	Bearing	
10	112521350/0	2	Washer	
11	112155000/0	2	Nut	
12	322110597/0	2	Hub Cap	
13	381002034/0	1	Rod, Height Adjustment	
14	112436051/0	2	Plate	
15	122450459/1	1	Spring	
16	381003337/1	1	Lever, Height Adjustment	
17	322570202/0	1	Cover	
21	322602012/1	1	Button	
22	122450462/0	1	Spring	
23	112000930/0	1	Snap Ring	
24	122033351/1	1	Rod	
25	381002899/0	1	Axle, Rear Wheels	
26	322600179/0	2	Protection, Wheel	
27	112728691/0	6	Screw	
28	322120113/0	2	Ring Gear	
29	381007398/1	2	Wheel Ø 300	
30	119216035/0	4	Bearing	
31	112521350/0	2	Washer	
32	112155000/0	2	Nut	
33	322110598/0	2	Hub Cap	

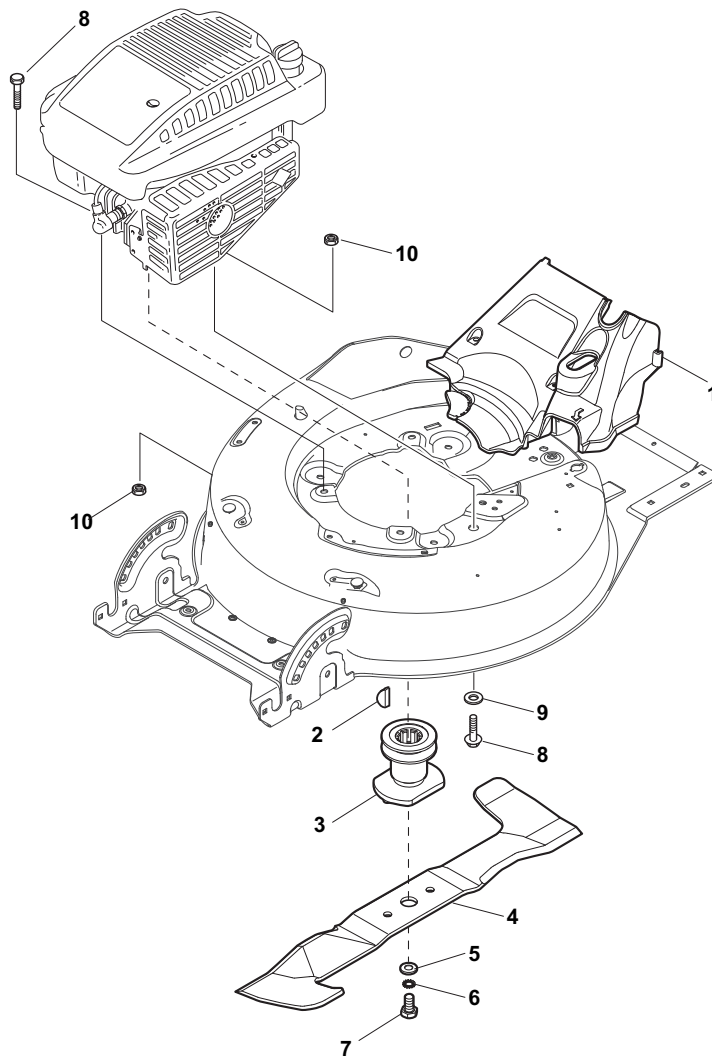

POSITION	PART No.	Q.Ty	DESCRIPTION	NOTES
1	322060230/0	1	Protection	
2	112139100/0	1	Feather, Crankshaft Ø 22.2	
4	181004451/0	1	Blade	
5	122160400/0	1	Elastic Washer	
6	112523080/0	1	Washer	
7	112736815/0	1	Screw	
8	112691100/0	3	Screw	
9	112521350/0	1	Washer	
10	112154210/0	3	Nut	

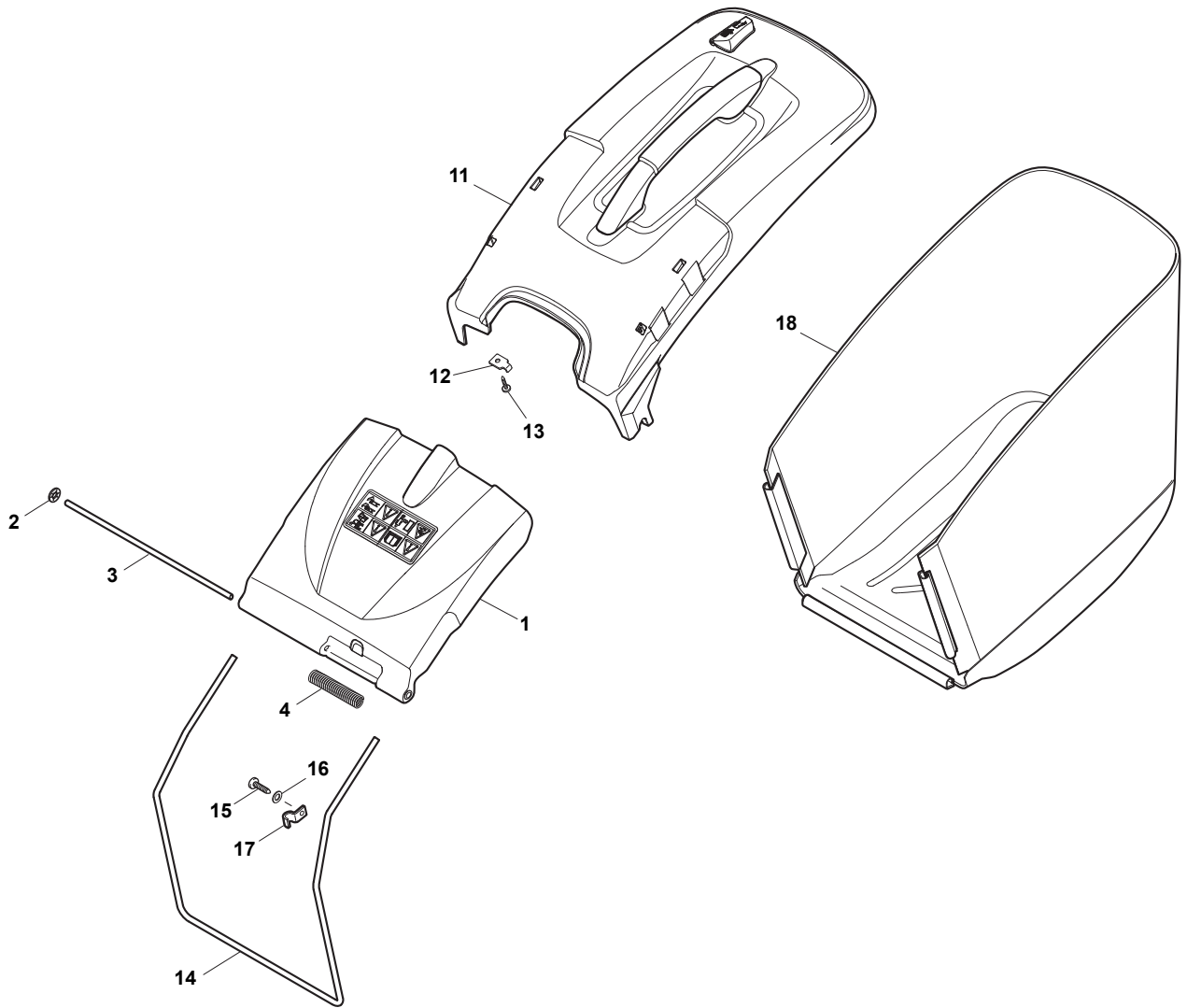

POSITION	PART No.	Q.Ty	DESCRIPTION	NOTES
1	322600180/4	1	Stone-Guard	
2	112604899/0	2	Crown Fastener	
3	122517863/0	1	Pin	
4	122450455/1	1	Spring	
11	381486007/0	1	Grass-Box, Upper Part	
12	322545159/0	2	Plate	
13	112728689/0	2	Screw	
14	122608542/0	1	Stiffening Lower	
15	112728689/0	2	Screw	
16	112521320/0	2	Washer	
17	325774220/0	2	Plate	
18	181002302/2	1	Box, Fabric	